

# HPY Series Pneumatic Actuator



**FLWSPEC LUOKAI INDUSTRIAL CO., LTD.**



## Content

Brief Introduction	03	Output Torque of Double Acting Actuator	11
Structural Features	05	Output Torque of HPY- B Spring Return Actuator (FC)	13
Performance Characteristics	07	Output Torque of HPY- B Spring Return Actuator (FO)	15
Parts and Materials	09	Output Torque of HPY- C Spring Return Actuator (FC)	17





Output Torque of HPY- C Spring Return Actuator (FO)	19	Dimension of HPY- C Spring Return Actuator (FC)	25
Sizing	20	Dimension of HPY- C Spring Return Actuator (FO)	27
Dimension of HPY- B (C) Double Acting Actuator	21	Modular Design	29
Dimension of HPY- B Spring Return Actuator [FC(O)]	23	Body connecting dimension / How to order	30

## Structural Features

### Design and Construction

HPY series pneumatic and hydraulic actuators provide global customers with the latest in valve actuation design. It is a highly unique and reliable means of operating ball, butterfly or plug valves along with 90 degree rotating mechanisms.

### Minimum Maintenance

Every HPY actuator is built to provide long and efficient service with minimum maintenance. The design, engineering and materials used in their construction ensure optimum performance even in the harshest of environments.

### Modular Design

HPY series actuators share a modular construction design. The centre body is available in six sizes. A pneumatic or hydraulic cylinder can be attached to either or both sides. A spring cartridge can also be fitted to either side for ESD (emergency shut down) applications. Modular construction and stocking of components by facilitates quick delivery times.

### Robust Yet Lightweight Design

Totally enclosed weatherproof centrebody fabricated in carbon steel or ductile iron provide an excellent strength to weight ratio. The mechanism of piston and yoke has an advantage torque output.

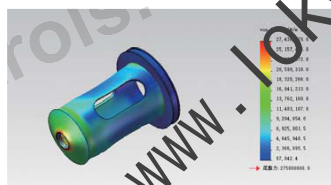
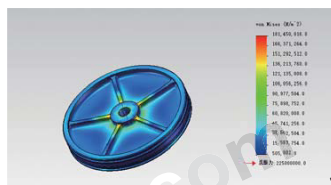
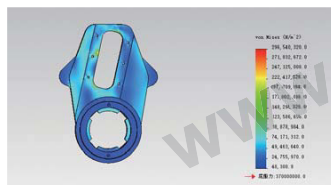

### Extensive Product Range

ST.HANS offers the most extensive line of fluid power valve actuators. Products include low and high pressure pneumatic, hydraulic and pneumatic-hydraulic actuators.

### Manual Override Options

A dependable manual override facility is an important part many valve/actuator applications. ST.HANS has a variety of override options available to meet virtually any requirement. Available options include open or enclosed screws in both gear reducer and, declutch override gear box, as well as a number of hydraulic override solutions.

### Complete Control Solutions

Air Control component packages are a part of any actuator/valve installation. ST.HANS has extensive experience in the design and assembly of all types of air control systems to satisfy any customer requirement for on/off, control or ESD service. Packages can be mounted on a panel or in a cabinet and mounted either on the actuator or at a remote location.

## Performance Characteristics

The pinion conform to the latest standards of ISO5211, NAMUR. The dimensions can be customized and the stainless steel is available.

Position indicator with NAMUR is convenient for mounting accessories such as Limit Switch box, Positioner and so on.

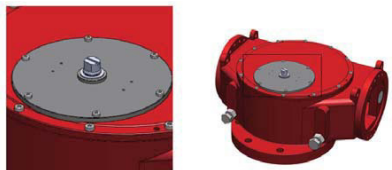

The different materials rubber and PFA encapsulated O-rings can be used in a wider range of temperature and condition.

The double O-ring and bearing design ensure the stability and dependability of the cylinder modular.



Operating Ranges HPY actuators have torque outputs for spring-return models in excess of 110,000 Nm and double-acting models in excess of 240,000 Nm.

Operating pressures are: 3~10Bar

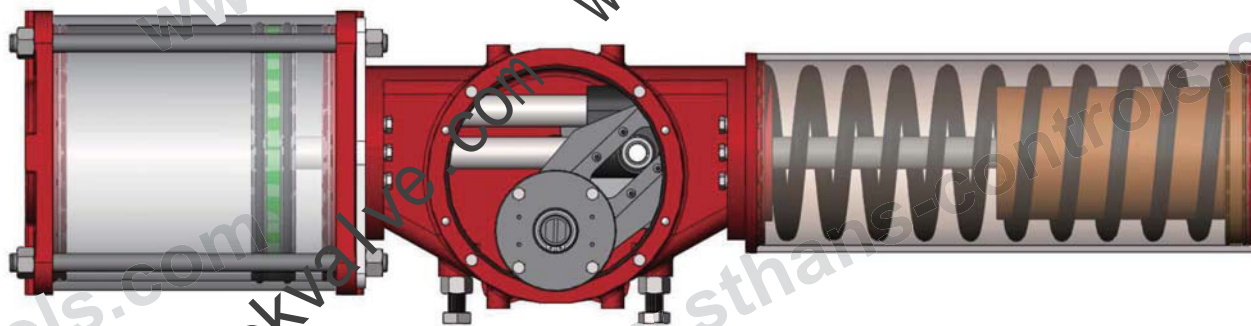

Operating temperatures standard -20°C to +80°C.

Optional trims include:

High Temperature -15°C to +150°C

Low Temperature -40°C to +80°C

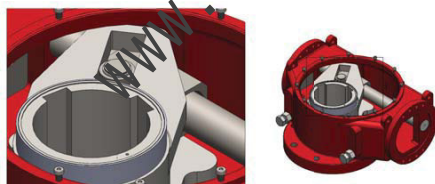

Made from low friction, long-life compound material, to avoid the direct contact between metals. The maintenance and replacement are easy and convenient.

The Mounting Flange is up to the ISO 5211.

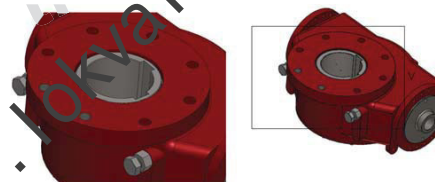

HPY actuators are available with either B or C body modules. The B body modules provide efficient operation at both the break and end positions. The C body modules have a torque advantage in applications where higher break torque is needed to unseat the valve, with less critical needs at the run or full open positions.

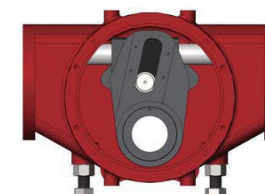
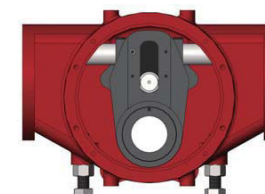

Integral bi-directional travel stops, adjustable from -6° to 96° of total valve travel, assist the HP Series in prolonging valve seat integrity.

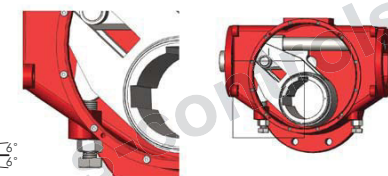
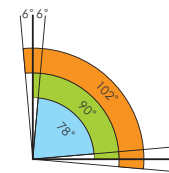



**Parts and Materials**

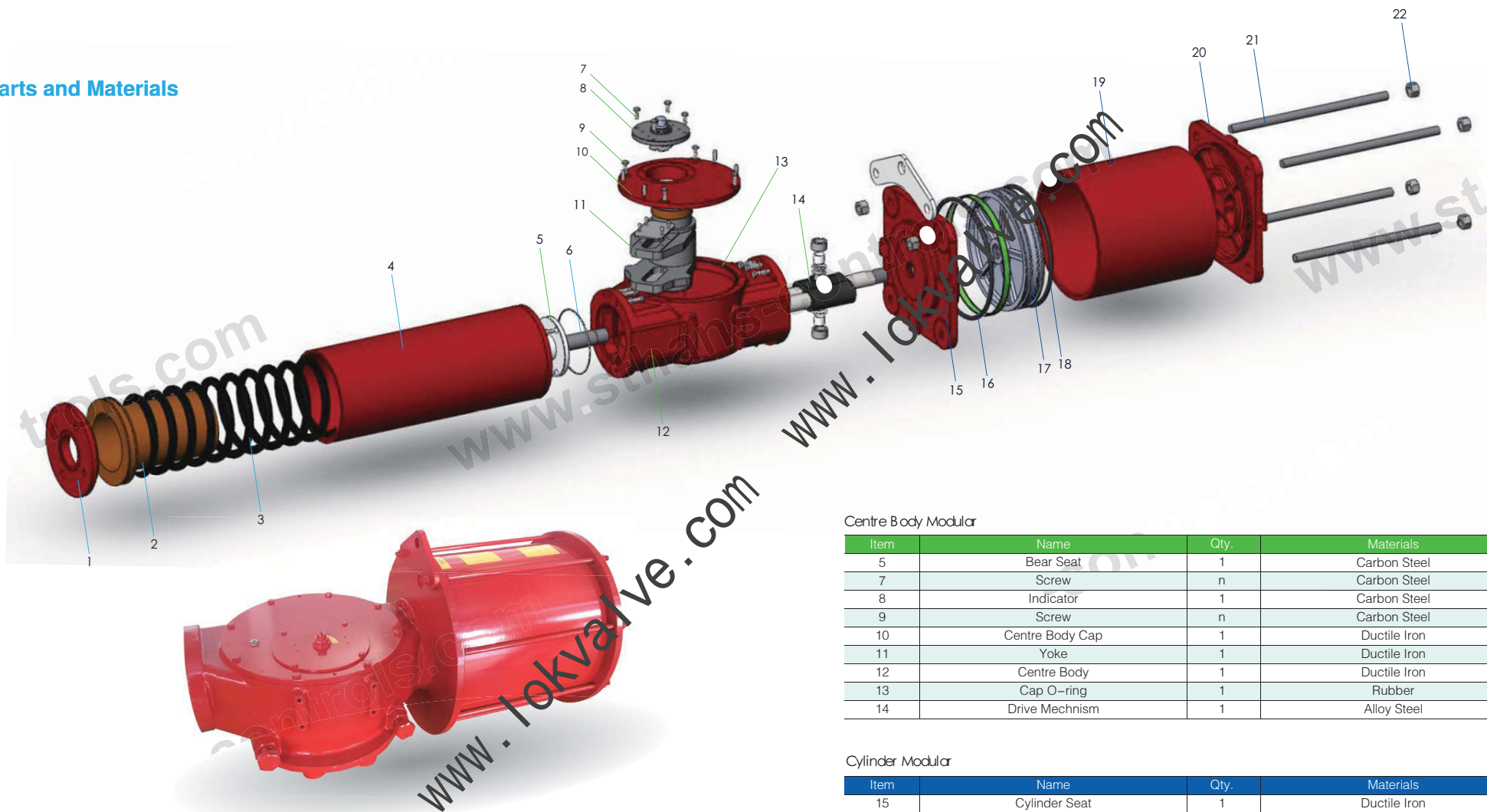

**Spring Modular**

Item	Name	Qty.	Materials
1	Flange Cap	1	Carbon Steel
2	Spring Seat	1	Carbon Steel
3	Spring	1	Spring Steel
4	Spring Body	1	Carbon Steel
6	Spring Stem	1	Alloy Steel

**Centre Body Modular**

Item	Name	Qty.	Materials
5	Bear Seat	1	Carbon Steel
7	Screw	n	Carbon Steel
8	Indicator	1	Carbon Steel
9	Screw	n	Carbon Steel
10	Centre Body Cap	1	Ductile Iron
11	Yoke	1	Ductile Iron
12	Centre Body	1	Ductile Iron
13	Cap O-ring	1	Rubber
14	Drive Mechanism	1	Alloy Steel

**Cylinder Modular**

Item	Name	Qty.	Materials
15	Cylinder Seat	1	Ductile Iron
16	O Ring	1	Rubber
17	Piston	1	Carbon Steel
18	Guide Ring	1	Resin
19	Cylinder Body	1	Carbon Steel
20	Cylinder Cap	1	Ductile Iron
21	Screw	n	Carbon Steel
22	Screw Nut	n	Carbon Steel

### Output Torque of HPY- B Series Double Acting Actuator

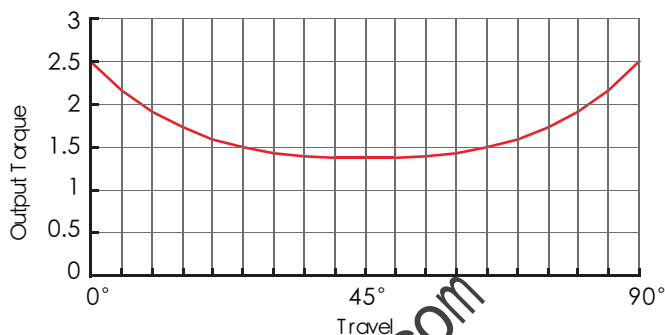

Model	Output Torque (Nm)									Air Pressure (Mpa)		
	0.35			0.4			0.5			0.6		
	0°	45°	90°	0°	45°	90°	0°	45°	90°	0°	45°	90°
HPY-B06-201-DA	1269	670	1269	1451	766	1451	1814	998	1814	2154	1138	2154
HPY-B08-221-DA	2000	1056	2000	2286	1207	2286	2857	1509	2857	3428	1810	3428
HPY-B08-251-DA	2599	1372	2599	2970	1568	2970	3712	1960	3712	4455	2352	4455
HPY-B1-281-DA	3836	2026	3836	4384	2315	4384	5480	2894	5480	6576	3473	6576
HPY-B1-321-DA	5035	2659	5035	5754	3039	5754	7193	3798	7193	8631	4558	8631
HPY-B1-351-DA	6039	3189	6039	6902	3644	6902	8627	4556	8627			
HPY-B2-351-DA	7193	3798	7193	8220	4341	8220	10275	5426	10275	12330	6511	12330
HPY-B2-401-DA	9440	4985	9440	10789	5697	10789	13486	7122	13486	16184	8546	16184
HPY-B2-451-DA	11988	6330	11988	13700	7235	13700	17126	9043	17126			
HPY-B3-451-DA	14306	7555	14306	16350	8634	16350	20438	10792	20438	24525	12951	24525
HPY-B3-501-DA	17723	9359	17723	20458	10696	20255	25318	13369	25318	30382	16043	30382
HPY-B3-561-DA	22297	11774	22297	25483	13456	25483	31854	16820	31854	38224	20184	38224
HPY-B3-601-DA	25635	13537	25635	29297	15470	29297	36621	19338	36621			
HPY-B4-601-DA	30797	16263	30797	35197	18586	35197	43996	23232	43996	52796	27879	52796
HPY-B4-631-DA	33986	17946	33986	38841	20510	38841	48552	25638	48552	58262	30765	58262
HPY-B4-502-DA	42584	22487	42584	48668	25699	48668	60835	32124	60835			
HPY-B4-701-DA	42031	22195	42031	48036	25365	48036	60044	31707	60044			
HPY-B4-562-DA	53576	28291	53576	61230	32332	61230						
HPY-B4-801-DA	54949	29039	54949	62849	33188	62849						
HPY-B5-701-DA	50399	26614	50399	57599	30416	57599	71999	38019	71999	86399	45623	86399
HPY-B5-562-DA	64145	33872	64145	73308	38711	73308	91635	48388	91635	109963	58066	109963
HPY-B5-801-DA	65984	34843	65984	75410	39820	75410	94263	49776	94263	113115	59731	113115
HPY-B5-602-DA	73786	38963	73786	84327	44529	84327	105409	55661	105409	126491	66794	126491
HPY-B5-632-DA	81454	43012	81454	93090	49156	93090	116362	61446	116362			
HPY-B5-901-DA	83646	44169	83646	95595	50479	95595	119494	63099	119494			
HPY-B5-702-DA	100799	53227	100799	115199	60831	115199						
HPY-B5-1001-DA	103386	54593	103386	118155	62392	118155						
HPY-B6-901-DA	112390	59348	112390	128446	67826	128446	160558	84783	160558	192669	101740	192669
HPY-B6-702-DA	135271	71430	135271	154596	81635	154596	193245	102043	193245	231894	122452	231894
HPY-B6-1001-DA	138964	73380	138964	158816	83863	158816	198519	104829	198519	238223	125795	238223
HPY-B6-802-DA	177229	93586	177229	202547	106956	202547	253184	133695	253184			
HPY-B6-902-DA	224781	118696	224781	256893	135653	256893						

### Output Torque of HPY- C Series Double Acting Actuator

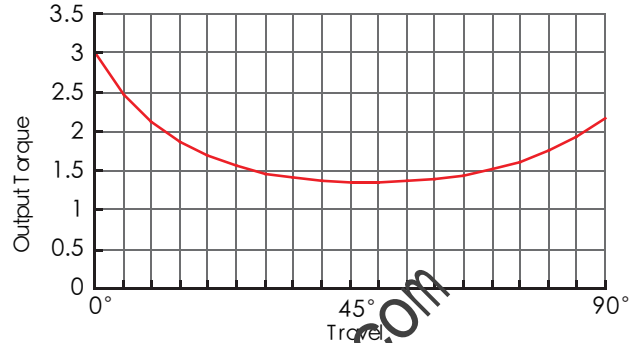

Model	Output Torque (Nm)									Air Pressure (Mpa)		
	0.35			0.4			0.5			0.6		
	0°	45°	90°	0°	45°	90°	0°	45°	90°	0°	45°	90°
HPY-C06-201-DA	1523	663	1068	1741	758	1220	2176	941	1525			
HPY-C08-221-DA	2400	1045	1682	2743	1194	1922	3428	1493	2403	4114	1792	2883
HPY-C08-251-DA	3118	1358	2185	3564	1552	2498	4455	1940	3122			
HPY-C1-281-DA	4603	2005	3226	5261	2291	3687	6576	2864	4609	7891	3436	5531
HPY-C1-321-DA	6042	2631	4234	6905	3007	4819	8631	3759	6049			
HPY-C2-351-DA	8631	3759	6049	9864	4265	6913	12330	5369	8642	14796	6443	10370
HPY-C2-401-DA	11329	4933	7939	12947	5638	9074	16184	7047	11342	19420	8457	13610
HPY-C2-451-DA	14385	6264	10082	16441	7159	11522						
HPY-C3-451-DA	17168	7476	12032	19620	8544	13750	24525	10680	17188	29430	12816	20626
HPY-C3-501-DA	21267	9261	14905	24306	10584	17034	30382	13230	21293			
HPY-C3-561-DA	26757	11652	18752	30579	13316	21431						
HPY-C4-561-DA	32146	13996	22529	36738	15998	25747	45922	19997	32184	55107	23997	38621
HPY-C4-601-DA	36957	16043	25901	42237	18392	29601	52796	22990	37001	63355	27589	44401
HPY-C4-631-DA	40783	17760	28582	46610	20297	32666	58262	25371	40832			
HPY-C4-701-DA	50492	21963	35348	57643	25101	40398						
HPY-C5-701-DA	60479	26336	42386	69119	30099	48441	86399	37623	60551	103679	45148	72662
HPY-C5-562-DA	76974	33519	53946	87970	38307	61652	109963	47884	77065	131955	57461	92478
HPY-C5-801-DA	79181	34480	55492	90492	39406	63420	113115	49257	79275	135738	59109	95130
HPY-C5-602-DA	88544	38557	62054	101193	44065	70919	126491	55082	88649			
HPY-C5-632-DA	97744	42564	68503	111708	48644	78289						
HPY-C5-901-DA	100375	43709	70346	114714	49954	80396						
HPY-C6-801-DA	106337	46306	74525	121528	52921	85171	151911	66151	106464	182293	79381	127757
HPY-C6-901-DA	134869	58730	94520	154136	67120	108023	192669	83900	135029	231203	100680	162035
HPY-C6-702-DA	162326	70686	113763	185515	80784	130015	231894	100981	162519			
HPY-C6-1001-DA	166756	72616	116868	190579	82989	133564	238223	103737	166955			
HPY-C6-802-DA	212675	92611	149050	243057	105842	170342						



### Output Torque of HPY- B Series Actuator with Spring Return (FC)

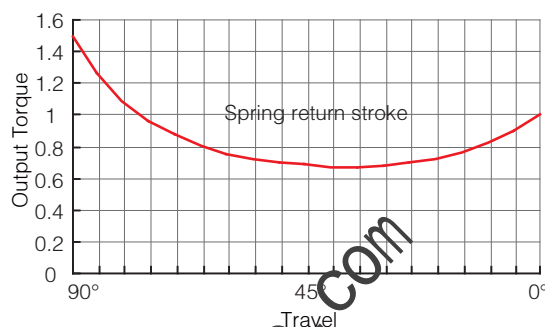
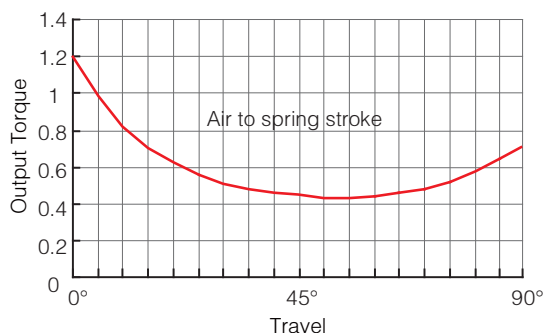

Model	Air to Spring (4Bar)			Spring			Air to Spring (5Bar)			Spring			Air to Spring (6Bar)			Spring		
	0°	45°	90°	90°	45°	0°	0°	45°	90°	90°	45°	0°	0°	45°	90°	90°	45°	0°
HPY-B06-201-SRC4	934	383	549	902	383	517	1296	575	911	902	383	517	1659	766	1274	902	383	517
HPY-B06-201-SRC5							1167	479	686	1128	479	646	1530	670	1049	1128	479	646
HPY-B06-201-SRC6													1391	567	806	1370	582	785
HPY-B06-221-SRC4	1116	452	635	1128	479	646	1557	685	1076	1128	479	646	1997	917	1516	1128	479	646
HPY-B06-221-SRC5							1418	582	837	1370	582	785	1858	814	1274	1370	582	785
HPY-B06-221-SRC6													1701	698	1000	1644	698	942
HPY-B08-221-SRC4	1449	587	834	1452	620	837	2020	889	1405	1452	620	837	2591	1190	1976	1452	620	837
HPY-B08-221-SRC5							1830	748	1075	1782	761	1027	2401	1049	1646	1782	761	1027
HPY-B08-221-SRC6													2132	850	1180	2248	960	1296
HPY-B08-251-SRC4	1943	807	1188	1782	761	1027	2685	1199	1930	1782	761	1027	3428	1591	2673	1782	761	1027
HPY-B08-251-SRC5							2416	1000	1464	2248	960	1296	3159	1392	2207	2248	960	1296
HPY-B08-251-SRC6													2828	1147	1633	2822	1205	1627
HPY-B08-281-SRC4	2445	1016	1493	2248	960	1296	3381	1509	2429	2248	960	1296	4316	2003	3364	2248	960	1296
HPY-B08-281-SRC5							3050	1264	1855	2822	1205	1627	3985	1758	2790	2822	1205	1627
HPY-B08-281-SRC6													3612	1481	2142	3470	1482	2000
HPY-B1-281-SRC4	2821	1157	1670	2714	1158	1563	3917	1736	2766	2714	1158	1563	5013	2315	3862	2714	1158	1563
HPY-B1-281-SRC5							3478	1411	2004	3476	1483	2002	4574	1990	3100	3476	1483	2002
HPY-B1-281-SRC6													4116	1651	2305	4271	1822	2460
HPY-B1-321-SRC4	3752	1556	2278	3476	1483	2002	5191	2315	3717	3476	1483	2002	6629	3075	5155	3476	1483	2002
HPY-B1-321-SRC5							4733	1976	2922	4271	1822	2460	6171	2736	4360	4271	1822	2460
HPY-B1-321-SRC6													5408	2171	3034	5597	2387	3223
HPY-B1-351-SRC4	4442	1822	2631	4271	1822	2460	6167	2734	4356	4271	1822	2460	7892	3645	6081	4271	1822	2460
HPY-B1-351-SRC5							5404	2169	3030	5597	2387	3223	7129	3080	4755	5597	2387	3223
HPY-B1-351-SRC6													6323	2483	3356	6996	2984	4029
HPY-B1-401-SRC4	5819	2388	3445	5597	2387	3223	8080	3582	5706	5597	2387	3223	10340	4775	7966	5597	2387	3223
HPY-B1-401-SRC5							7274	2985	4307	6996	2984	4029	9534	4178	6567	6996	2984	4029
HPY-B1-401-SRC6													8729	3581	5168	8395	3581	4834
HPY-B2-401-SRC4	6943	2848	4110	6679	2849	3846	9640	4273	6807	6679	2849	3846	12338	5697	9505	6679	2849	3846
HPY-B2-401-SRC5							8603	3505	5005	8481	3617	4883	11301	4929	7703	8481	3617	4883
HPY-B2-401-SRC6													10080	4024	5582	10602	4522	6104

Model	Air to Spring (4Bar)			Spring			Air to Spring (5Bar)			Spring			Air to Spring (6Bar)			Spring		
	0°	45°	90°	90°	45°	0°	0°	45°	90°	90°	45°	0°	0°	45°	90°	90°	45°	0°
HPY-B2-451-SRC4	8817	3618	5219	8481	3617	4883	12243	5426	8645	8481	3617	4883	15668	7235	12070	8481	3617	4883
HPY-B2-451-SRC5							11022	4521	6524	10602	4522	6104	14447	6330	9949	10602	4522	6104
HPY-B2-451-SRC6													13226	5426	7829	12722	5426	7325
HPY-B3-451-SRC4	10522	4317	6232	10118	4317	5828	14610	6475	10320	10118	4317	5828	18697	8634	14407	10118	4317	5828
HPY-B3-451-SRC5							13186	5420	7847	12591	5372	7252	17273	7579	13344	12591	5372	7252
HPY-B3-451-SRC6													15500	6266	10857	15668	6685	9025
HPY-B3-501-SRC4	13003	5324	7664	12591	5372	7252	18066	7997	12727	12591	5372	7252	23130	70671	17791	12591	5372	7252
HPY-B3-501-SRC5							16293	6684	9650	15668	6685	9025	21357	9358	14714	15668	6685	9025
HPY-B3-501-SRC6													19028	7633	10671	19711	8410	11354
HPY-B3-561-SRC4	16458	6771	9815	15668	6685	9025	22829	10135	16186	15668	6685	9025	29199	13499	22556	15668	6685	9025
HPY-B3-561-SRC5							20500	8410	12143	19711	8410	11354	26870	11774	18513	19711	8410	11354
HPY-B3-561-SRC6													24600	10092	14570	23654	10092	13624
HPY-B3-631-SRC4	20977	8662	12619	19711	8410	11354	29059	12930	20702	19711	8410	11354	37142	17198	28784	19711	8410	11354
HPY-B3-631-SRC5							26788	11248	16759	13854	10092	13624	34871	15516	24842	23654	10092	13624
HPY-B3-631-SRC6													31210	12804	18486	30010	12804	17286
HPY-B4-631-SRC4	24997	10255	14784	24057	10255	13844	34708	15383	24495	24057	10255	13844	44418	20510	34205	24057	10255	13844
HPY-B4-631-SRC5							31246	12819	18481	30071	12819	17306	40956	17946	28191	30071	12819	17306
HPY-B4-631-SRC6													35860	14171	19335	38927	16594	22402
HPY-B4-701-SRC4	30730	12546	17964	30071	12819	17306	42739	18888	29973	30071	12819	17306	54748	25229	41982	30071	12819	17306
HPY-B4-701-SRC5							37643	15113	21118	38927	16594	22402	49651	21454	33126	38927	16594	22402
HPY-B4-701-SRC6													44052	17306	23396	48657	20742	28002
HPY-B4-801-SRC4	40447	16594	23922	38927	16594	22402	56160	24891	39635	38927	16594	22402	71872	33188	55347	38927	16594	22402
HPY-B4-801-SRC5							50560	20743	29904	48657	20742	28002	66272	29040	45616	48657	20742	28002
HPY-B4-801-SRC6													60671	24891	35884	58390	24891	33603
HPY-B5-801-SRC4	48531	19910	28703	46707	19910	26879	67384	29865	47556	46707	19910	26879	86236	39820	66408	46707	19910	26879
HPY-B5-801-SRC5							60189	24536	35054	59209	25240	34074	79041	34491	53906	59209	25240	34074
HPY-B5-801-SRC6													70523	28181	39104	74011	31550	42592
HPY-B5-901-SRC4	61522	25240	36387	59209	25240	34074	85421	37860	60285	59209	25240	34074	109319	50479	84184	59209	25240	34074
HPY-B5-901-SRC5							76902	31550	45483	74011	31550	42592	100801	44169	69382	74011	31550	42592
HPY-B5-901-SRC6													92283	37860	54580	88813	37860	51110
HPY-B6-801-SRC4	65176	26739	38729	62545	26739	36098	90495	40108	64047	62545	26739	36098	115813	53478	89365	62545	26739	36098
HPY-B6-801-SRC5							80809	32934	47266	79327	33913	45783	106128	46304	72584	79327	33913	45783
HPY-B6-801-SRC6													94682	37825	52752	99158	42392	57229
HPY-B6-901-SRC4	82663	33913	49120	79327	33913	45783	114775	50870	81231	79327	33913	45783	146887	67826	113343	79327	33913	45783
HPY-B6-901-SRC5							103329	42392	61400	99158	42392	57229	135441	59348	93511	99158	42392	57229
HPY-B6-901-SRC6													121910	49325	70067	122603	52414	70759
HPY-B6-1001-SRC4	101587	41472	59657	99158	42392	57229	141291	62437	99361	99158	42392	57229	180995	83403	139065	99158	42392	57229
HPY-B6-1001-SRC5							127760	52414	75917	122603	52414	70759	167464	73380	115621	122603	52414	70759
HPY-B6-1001-SRC6													153312	62897	91100	147123	62897	84911

The torque of the springs can be customized to your needs.

### Output Torque of HPY- B Series Actuator with Spring Return (FO)

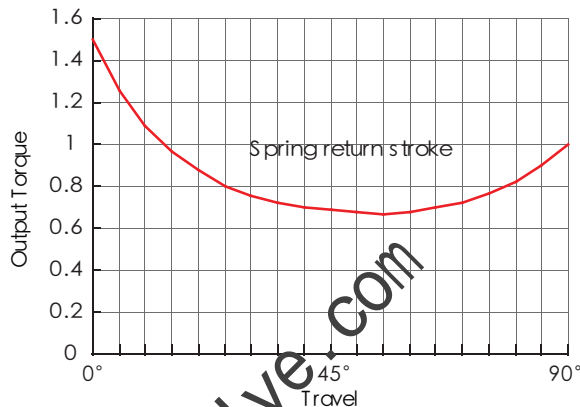
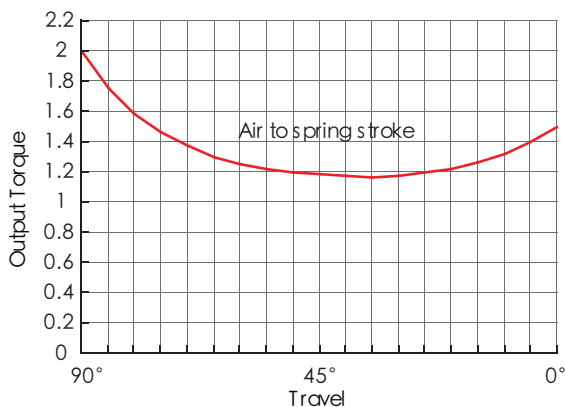

Model	Air to Spring (4Bar)			Spring			Air to Spring (5Bar)			Spring			Air to Spring (6Bar)			Spring		
	90°	45°	0°	0°	45°	90°	90°	45°	0°	0°	45°	90°	90°	45°	0°	0°	45°	90°
HPY-B06-201-SRO4	934	383	549	902	383	517	1296	575	911	902	383	517	1659	766	1274	902	383	517
HPY-B06-201-SRO5							1167	479	686	1128	479	646	1530	670	1049	1128	479	646
HPY-B06-201-SRO6													1391	567	806	1370	582	785
HPY-B06-221-SRO4	1116	452	635	1128	479	646	1557	685	1027	1128	479	646	1997	917	1516	1128	479	646
HPY-B06-221-SRO5							1418	582	837	1370	582	785	1858	814	1274	1370	582	785
HPY-B06-221-SRO6													1701	698	1000	1644	698	942
HPY-B08-221-SRO4	1449	587	834	1452	620	837	2076	889	1405	1452	620	837	2591	1190	1976	1452	620	837
HPY-B08-221-SRO5							1837	748	1075	1782	761	1027	2401	1049	1646	1782	761	1027
HPY-B08-221-SRO6													2132	850	1180	2248	960	1296
HPY-B08-251-SRO4	1943	807	1188	1782	761	1027	2685	1199	1930	1782	761	1027	3428	1591	2673	1782	761	1027
HPY-B08-251-SRO5							2416	1000	1464	2248	960	1296	3159	1392	2207	2248	960	1296
HPY-B08-251-SRO6													2828	1147	1633	2822	1205	1627
HPY-B08-281-SRO4	2445	1016	1493	2248	960	1296	3381	1509	2429	2248	960	1296	4316	2003	3364	2248	960	1296
HPY-B08-281-SRO5							3050	1264	1855	2822	1205	1627	3985	1758	2790	2822	1205	1627
HPY-B08-281-SRO6													3612	1481	2142	3470	1482	2000
HPY-B1-281-SRO4	2821	1117	1670	2714	1158	1563	3917	1736	2766	2714	1158	1563	5013	2315	3862	2714	1158	1563
HPY-B1-281-SRO5							3478	1411	2004	3476	1483	2002	4574	1990	3100	3476	1483	2002
HPY-B1-281-SRO6													4116	1651	2305	4271	1822	2460
HPY-B1-321-SRO4	3752	1556	2278	3476	1483	2002	5191	2315	3717	3476	1483	2002	6629	3075	5155	3476	1483	2002
HPY-B1-321-SRO5							4733	1976	2922	4271	1822	2460	6171	2736	4360	4271	1822	2460
HPY-B1-321-SRO6													5408	2171	3034	5597	2387	3223
HPY-B1-351-SRO4	4442	1822	2631	4271	1822	2460	6167	2734	4356	4271	1822	2460	7892	3645	6081	4271	1822	2460
HPY-B1-351-SRO5							5404	2169	3030	5597	2387	3223	7129	3080	4755	5597	2387	3223
HPY-B1-351-SRO6													6323	2483	3356	6996	2984	4029
HPY-B1-401-SRO4	5819	2388	3445	5597	2387	3223	8080	3582	5706	5597	2387	3223	10340	4775	7966	5597	2387	3223
HPY-B1-401-SRO5							7274	2985	4307	6996	2984	4029	9534	4178	6567	6996	2984	4029
HPY-B1-401-SRO6													8729	3581	5168	8395	3581	4834
HPY-B2-401-SRO4	6943	2848	4110	6679	2849	3846	9640	4273	6807	6679	2849	3846	12338	5697	9505	6679	2849	3846
HPY-B2-401-SRO5							8603	3505	5005	8481	3617	4883	11301	4929	7703	8481	3617	4883
HPY-B2-401-SRO6													10080	4024	5582	10602	4522	6104



Model	Air to Spring (4Bar)			Spring			Air to Spring (5Bar)			Spring			Air to Spring (6Bar)			Spring		
	90°	45°	0°	0°	45°	90°	90°	45°	0°	0°	45°	90°	90°	45°	0°	0°	45°	90°
HPY-B2-451-SRO4	8817	3618	5219	8481	3617	4883	12243	5426	8645	8481	3617	4883	15668	7235	12070	8481	3617	4883
HPY-B2-451-SRO5							11022	4521	6524	10602	4522	6104	14447	6330	9949	10602	4522	6104
HPY-B2-451-SRO6													13226	5426	7829	12722	5426	7325
HPY-B3-451-SRO4	10522	4317	6232	10118	4317	5828	14610	6475	10320	10118	4317	5828	18697	8634	14447	10118	4317	5828
HPY-B3-451-SRO5							13186	5420	7847	12591	5372	7252	17273	7579	11934	12591	5372	7252
HPY-B3-451-SRO6													15500	6266	8857	15668	6685	9025
HPY-B3-501-SRO4	13003	5324	7664	12591	5372	7252	18066	7997	12727	12591	5372	7252	23136	10671	17791	12591	5372	7252
HPY-B3-501-SRO5							16293	6684	9650	15668	6685	9025	21357	9358	14714	15668	6685	9025
HPY-B3-501-SRO6													19028	7633	10671	19711	8410	11354
HPY-B3-561-SRO4	16458	6771	9815	15668	6685	9025	22829	10135	16186	15668	6685	9025	29199	13499	22556	15668	6685	9025
HPY-B3-561-SRO5							20500	8410	12143	19711	8410	11354	26870	11774	18513	19711	8410	11354
HPY-B3-561-SRO6													24600	10092	14570	23654	10092	13624
HPY-B3-631-SRO4	20977	8662	12619	19711	8410	11354	29059	12930	20704	19711	8410	11354	37142	17198	28784	19711	8410	11354
HPY-B3-631-SRO5							26788	11248	16739	23654	10092	13264	34871	15516	24842	23654	10092	13624
HPY-B3-631-SRO6													31210	12804	18486	30010	12804	17286
HPY-B4-631-SRO4	24997	10255	14784	24057	10255	13844	34708	15383	24495	24057	10255	13844	44418	20510	34205	24057	10255	13844
HPY-B4-631-SRO5							31246	12819	18481	30071	12819	17306	40956	17946	28191	30071	12819	17306
HPY-B4-631-SRO6													35860	14171	19335	38927	16594	22402
HPY-B4-701-SRO4	30730	12546	17964	30071	12819	17306	42739	18888	29973	30071	12819	17306	54748	25229	41982	30071	12819	17306
HPY-B4-701-SRO5							37643	15113	21118	38927	16594	22402	49651	21454	33126	38927	16594	22402
HPY-B4-701-SRO6													44052	17306	23396	48657	20742	28002
HPY-B4-801-SRO4	40447	16594	23922	30071	12819	17306	56160	24891	39635	38927	16594	22402	71872	33188	55347	38927	16594	22402
HPY-B4-801-SRO5							50560	20743	29904	48657	20742	28002	66272	29040	45616	48657	20742	28002
HPY-B4-801-SRO6													60671	24891	35884	58390	24891	33603
HPY-B5-801-SRO4	48531	19191	28703	46707	19910	26879	67384	29865	47556	46707	19910	26879	86236	39820	66408	46707	19910	26879
HPY-B5-801-SRO5							60189	24536	35054	59209	25240	34074	79041	34491	53906	59209	25240	34074
HPY-B5-801-SRO6													70523	28181	39104	74011	31550	42592
HPY-B5-901-SRO4	61522	25240	36387	59209	25240	34074	85421	37860	60285	59209	25240	34074	109319	50479	84184	59209	25240	34074
HPY-B5-901-SRO5							76902	31550	45483	74011	31550	42592	100801	44169	69382	74011	31550	42592
HPY-B5-901-SRO6													92283	37860	54580	88813	37860	51110
HPY-B6-801-SRO4	65176	26739	38729	62545	26739	36098	90495	40108	64047	62545	26739	36098	115813	53478	89365	62545	26739	36098
HPY-B6-801-SRO5							80809	32934	47266	79327	33913	45783	106128	46304	72584	79327	33913	45783
HPY-B6-801-SRO6													94682	37825	52752	99158	42392	57229
HPY-B6-901-SRO4	82663	33913	49120	79327	33913	45783	114775	50870	81231	79327	33913	45783	146887	67826	113343	79327	33913	45783
HPY-B6-901-SRO5							103329	42392	61400	99158	42392	57229	135441	59348	93511	99158	42392	57229
HPY-B6-901-SRO6													121910	49325	70067	122603	52414	70759
HPY-B6-1001-SRO4	101587	41472	59657	99158	42392	57229	141291	62437	99361	99158	42392	57229	180995	83403	139065	99158	42392	57229
HPY-B6-1001-SRO5							127760	52414	75917	122603	52414	70759	167464	73380	115621	122603	52414	70759
HPY-B6-1001-SRO6													153312	62897	91100	147123	62897	84911

The torque of the springs can be customized to your needs.

### Output Torque of HPY- C Series Actuator with Spring Return (FC)

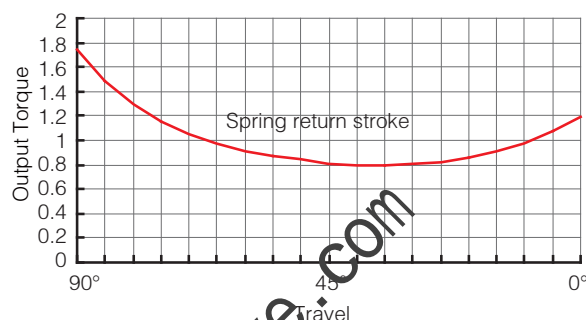
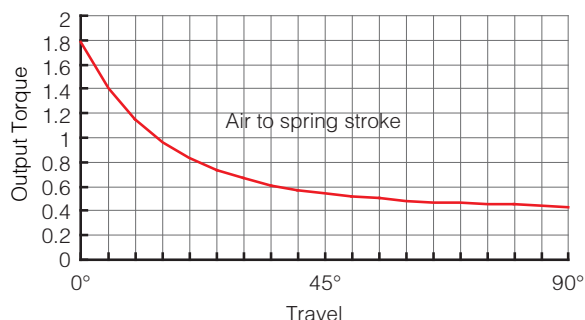

Model	Air to Spring (4Bar)			Spring			Air to Spring (5Bar)			Spring			Air to Spring (6Bar)			Spring		
	0°	45°	90°	90°	45°	0°	0°	45°	90°	90°	45°	0°	0°	45°	90°	90°	45°	0°
HPY-C06-201-SRC4	870	279	305	915	479	870	1306	468	610	915	479	870	1741	658	915	915	479	870
HPY-C06-201-SRC5							1088	348	381	1144	599	1088	1523	538	686	1144	599	1088
HPY-C06-201-SRC6													1290	409	440	1390	728	1322
HPY-C06-221-SRC4	1027	322	338	1144	599	1088	1556	552	708	1144	599	1088	2084	782	1079	1144	599	1088
HPY-C06-221-SRC5							1322	423	479	1390	728	1322	1851	653	833	1390	728	1322
HPY-C06-221-SRC6													1586	508	555	1668	874	1586
HPY-C08-221-SRC4	1353	427	460	1462	768	1390	2038	725	941	1462	768	1390	2724	1024	1421	1462	768	1390
HPY-C08-221-SRC5							1640	527	564	1838	966	1748	2366	826	1045	1838	966	1748
HPY-C08-221-SRC6													1887	561	541	2342	1230	2227
HPY-C08-251-SRC4	1816	586	659	1838	966	1748	2707	974	1284	1838	966	1748	3598	1362	1908	1838	966	1748
HPY-C08-251-SRC5							2227	710	780	2342	1230	2227	3118	1098	1404	2342	1230	2227
HPY-C08-251-SRC6													2606	814	865	2882	1513	2740
HPY-C08-281-SRC4	2262	725	804	2342	1230	2227	3385	1213	1591	2342	1230	2227	4507	1702	2377	2342	1230	2227
HPY-C08-281-SRC5							2872	930	1051	2882	1513	2740	3994	1419	1838	2882	1513	2740
HPY-C08-281-SRC6													3367	1073	1179	3541	1860	3367
HPY-C1-281-SRC4	2630	849	921	2766	1452	2630	3946	1411	1842	2766	1452	2630	5261	1984	2764	2766	1452	2630
HPY-C1-281-SRC5							3206	1003	1065	3544	1861	3370	4521	1576	1986	3544	1861	3370
HPY-C1-281-SRC6													3750	1150	1176	4355	2286	4141
HPY-C1-321-SRC4	3535	1146	1295	3544	1861	3370	5261	1898	2505	3544	1861	3370	6988	2650	3715	3544	1861	3370
HPY-C1-321-SRC5							4490	1472	1694	4355	2286	4141	6217	2224	2904	4355	2286	4141
HPY-C1-321-SRC6													5098	1606	1727	5532	2904	5260
HPY-C1-351-SRC4	4141	1320	1449	4355	2286	4141	6211	2222	2900	4355	2286	4141	8282	3123	4351	4355	2286	4141
HPY-C1-351-SRC5							5092	1604	1724	5532	2904	5260	7163	2506	3175	5532	2904	5260
HPY-C1-351-SRC6													5927	1823	1875	6832	3586	6496
HPY-C1-401-SRC4	5591	1821	2073	5532	2904	5260	8303	3002	3974	5532	2904	5260	11016	4184	5875	5532	2904	5260
HPY-C1-401-SRC5							7067	2320	2674	6832	3586	6496	9780	3501	4575	6832	3586	6496
HPY-C1-401-SRC6													8138	2595	2848	8559	4493	8138
HPY-C2-401-SRC4	6473	2064	2266	6808	3574	6473	9710	3474	4534	6808	3574	6473	12947	4883	6803	6808	3574	6473
HPY-C2-401-SRC5							7963	2509	2697	8645	4538	8220	11200	3919	4965	8645	4538	8220
HPY-C2-401-SRC6													9428	2941	3102	10508	5516	9992

Model	Air to Spring (4Bar)			Spring			Air to Spring (5Bar)			Spring			Air to Spring (6Bar)			Spring		
	0°	45°	90°	90°	45°	0°	0°	45°	90°	90°	45°	0°	0°	45°	90°	90°	45°	0°
HPY-C2-451-SRC4	8220	2621	2877	8645	4538	8220	12330	4411	5758	8645	4538	8220	16441	6201	8638	8645	4538	8220
HPY-C2-451-SRC5							10559	3433	3894	10508	5516	9992	14669	5223	6775	10508	5516	9992
HPY-C2-451-SRC6													12330	3932	4316	12967	6807	12330
HPY-C3-451-SRC4	9810	3127	3434	10317	5417	9810	14715	5263	6871	10317	5417	9810	19620	7399	10317	5417	9810	
HPY-C3-451-SRC5							12263	3909	4292	12896	6771	12263	17168	6045	7750	12896	6771	12263
HPY-C3-451-SRC6													14239	4428	4650	15976	8388	15191
HPY-C3-501-SRC4	12043	3813	4138	12896	6771	12263	18120	6459	8397	12896	6771	12263	24190	9105	12655	12896	6771	12263
HPY-C3-501-SRC5							15191	4842	5317	15976	8388	15191	21267	7489	9575	15976	8388	15191
HPY-C3-501-SRC6													17346	5324	5452	20100	10553	19112
HPY-C3-561-SRC4	15388	4928	5455	15976	8388	15191	23033	8257	10813	15976	8388	15191	30678	11586	16171	15976	8388	15191
HPY-C3-561-SRC5							19112	6092	6689	20100	10553	19112	26757	9421	12047	20100	10553	19112
HPY-C3-561-SRC6													23896	7842	9039	23108	12132	21973
HPY-C3-631-SRC4	19809	6396	7177	20100	10553	19112	29539	10633	13997	20100	10553	19112	39269	14870	20816	20100	10553	19112
HPY-C3-631-SRC5							23305	7191	7441	26656	13995	25346	33035	11428	14260	26656	13995	25346
HPY-C3-631-SRC6													29191	9305	10217	30699	16118	29191
HPY-C4-631-SRC4	21759	6584	6531	26135	13712	24851	33411	16538	14697	26135	13712	24851	45063	16732	22863	26135	13712	24851
HPY-C4-631-SRC5							29131	10297	10196	30636	16074	29131	40783	14371	18362	30636	16074	29131
HPY-C4-631-SRC6													33888	10566	11110	37888	19879	36027
HPY-C4-701-SRC4	28512	9027	9762	30636	16074	29131	42922	15302	19861	30636	16074	29131	57333	21578	29961	30636	16074	29131
HPY-C4-701-SRC5							36027	11497	12609	37888	19879	36027	50437	17773	22709	37888	19879	36027
HPY-C4-701-SRC6													41280	12719	13078	47519	24932	45184
HPY-C4-801-SRC4	39392	12963	14968	37888	19879	36027	58247	21173	28182	37888	19879	36027	77102	29384	41396	37888	19879	36027
HPY-C4-801-SRC5							49089	16120	18551	47519	24932	45184	67944	24331	31765	47519	24932	45184
HPY-C4-801-SRC6													56564	18052	19798	59487	31211	56564
HPY-C5-801-SRC4	45246	14968	15836	47584	24968	45246	67869	24289	31691	47584	24968	45246	90492	34141	47546	47584	24968	45246
HPY-C5-801-SRC5							55758	17606	18954	60321	31651	57357	78381	27457	34809	60321	31651	57357
HPY-C5-801-SRC6													65955	20601	21742	73388	38508	69783
HPY-C5-901-SRC4	57357	18302	20075	60321	31651	57357	86036	30791	40174	60321	31651	57357	114714	43279	60273	60321	31651	57357
HPY-C5-901-SRC5							73610	23934	27106	73388	38508	69783	102289	36423	47205	73388	38508	69783
HPY-C5-901-SRC6													86036	27454	30113	90481	47477	86036
HPY-C6-801-SRC4	60764	19336	21267	63904	33585	60764	91146	32566	42560	63904	33585	60764	121528	45796	63853	63904	33585	60764
HPY-C6-801-SRC5							74843	23555	25414	81050	42596	77068	105225	36785	46707	81050	42596	77068
HPY-C6-801-SRC6													88036	27284	28630	99127	52097	94257
HPY-C6-901-SRC4	77068	24524	26974	81050	42596	77068	115602	41304	53980	81050	42596	77068	154136	58084	80985	81050	42596	77068
HPY-C6-901-SRC5							98413	31803	35902	99127	52097	94257	136946	48583	62908	99127	52097	94257
HPY-C6-901-SRC6													113847	35815	38615	123420	64864	117357
HPY-C6-1001-SRC4	96322	30893	34437	99127	52097	94257	143967	51640	67828	99127	52097	94257	191611	72387	101219	99127	52097	94257
HPY-C6-1001-SRC5							120867	38872	43535	123420	64864	117357	168511	59620	76926	123420	64864	117357
HPY-C6-1001-SRC6													142934	45483	50027	150319	79001	142934

The torque of the springs can be customized to your needs.



### Output Torque of HPY- C Series Actuator with Spring Return (FO)

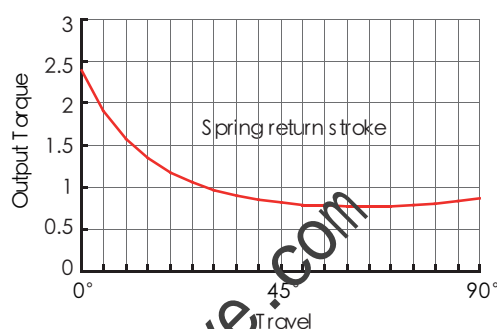
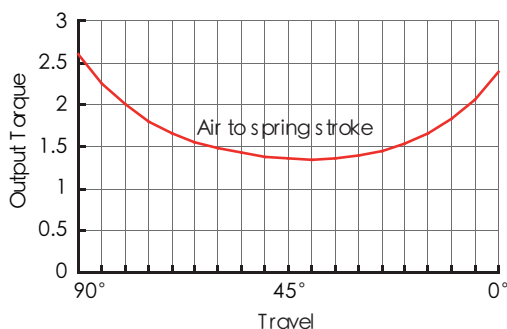

Model	Air to Spring (4Bar)			Spring			Air to Spring (5Bar)			Spring			Air to Spring (6Bar)			Spring		
	90°	45°	0°	0°	45°	90°	90°	45°	0°	0°	45°	90°	90°	45°	0°	0°	45°	90°
HPY-C06-201-SRO4	915	471	870	870	287	305	1221	660	1306	870	287	305	1526	850	1741	870	287	305
HPY-C06-201-SRO5							1144	589	1088	1088	359	381	1449	778	1523	1088	359	381
HPY-C06-201-SRO6													1368	701	1290	1322	436	463
HPY-C06-221-SRO4	1101	562	1027	1088	359	381	1472	792	1556	1088	359	381	1843	1023	2084	1088	359	381
HPY-C06-221-SRO5							1390	715	1322	1322	436	463	1761	945	1851	1322	436	463
HPY-C06-221-SRO6													1668	858	1586	1586	523	555
HPY-C08-251-SRO4	1436	735	1353	1390	459	487	1916	1083	2038	1390	459	487	2397	1332	2724	1390	459	487
HPY-C08-251-SRO5							1798	921	1699	1729	572	605	2278	1220	2385	1729	572	605
HPY-C08-251-SRO6													2104	1055	1887	2227	736	780
HPY-C08-251-SRO4	1892	980	1835	1729	572	605	2517	1368	2726	1729	572	605	3141	1756	3617	1729	572	605
HPY-C08-251-SRO5							2342	1204	2227	2227	736	780	2967	1591	3118	2227	736	780
HPY-C08-251-SRO6													2787	1422	2606	2740	906	959
HPY-C08-281-SRO4	2367	1219	2262	2227	736	780	3153	1707	3385	2227	736	780	3940	2196	4507	2227	736	780
HPY-C08-281-SRO5							2974	1538	2872	2740	906	959	3761	2027	3994	2740	906	959
HPY-C08-281-SRO6													3541	1819	3367	3367	1113	1179
HPY-C1-281-SRO4	2766	1383	2630	2630	869	921	3688	1994	3946	2630	869	921	4610	2567	5261	2630	869	921
HPY-C1-281-SRO5							3429	1750	3205	3371	1114	1180	4351	2322	4520	3371	1114	1180
HPY-C1-281-SRO6													4051	2039	3663	4228	1397	1480
HPY-C1-321-SRO4	3659	1893	3534	3371	1114	1180	4869	2645	5260	3371	1114	1180	6079	3396	6987	3371	1114	1180
HPY-C1-321-SRO5							4569	2361	4403	4228	1397	1480	5779	3113	6130	4228	1397	1480
HPY-C1-321-SRO6													5404	2759	5058	5300	1751	1855
HPY-C1-351-SRO4	4324	2209	4054	4228	1397	1480	5776	3111	6124	4228	1397	1480	7227	4013	8195	4228	1397	1480
HPY-C1-351-SRO5							5400	2757	5052	5300	1751	1855	6851	3658	7123	5300	1751	1855
HPY-C1-351-SRO6													6432	3263	5926	6497	2147	2274
HPY-C1-401-SRO4	5750	2974	5551	5300	1751	1855	7651	4155	8263	5300	1751	1855	9552	5336	10976	5300	1751	1855
HPY-C1-401-SRO5							7232	3759	7066	6497	2147	2274	9133	4941	9779	6497	2147	2274
HPY-C1-401-SRO6													8559	4398	8138	8138	2689	2848
HPY-C2-401-SRO4	6808	3499	6473	6473	2139	2266	9076	4908	9710	6473	2139	2266	11345	6318	12947	6473	2139	2266
HPY-C2-401-SRO5							8487	4352	8028	8156	2695	2855	10756	5762	11264	8156	2695	2855
HPY-C2-401-SRO6													10110	5153	9420	10000	3304	3500

Model	Air to Spring (4Bar)			Spring			Air to Spring (5Bar)			Spring			Air to Spring (6Bar)			Spring		
	90°	45°	0°	0°	45°	90°	90°	45°	0°	0°	45°	90°	90°	45°	0°	0°	45°	90°
HPY-C2-451-SRO4	8667	4464	8285	8156	2695	2855	11548	6254	12395	8156	2695	2855	14429	8044	16505	8156	2695	2855
HPY-C2-451-SRO5							10903	5645	10551	10000	3304	3500	13783	7435	14661	10000	3304	3500
HPY-C2-451-SRO6													12967	6665	12330	12330	4074	4316
HPY-C3-451-SRO4	10317	5302	9810	9810	3242	3434	13755	7438	14715	9810	3242	3434	17192	9574	16505	9810	3242	3434
HPY-C3-451-SRO5							12896	6627	12263	12263	4052	4292	16334	8763	14108	12263	4052	4292
HPY-C3-451-SRO6													15309	7796	14239	15191	5020	5317
HPY-C3-501-SRO4	12742	6532	12043	12263	4052	4292	17001	9178	18120	12263	4052	4292	21259	11824	24196	12263	4052	4292
HPY-C3-501-SRO5							15976	8210	15191	15191	5020	5317	20234	10856	21267	15191	5020	5317
HPY-C3-501-SRO6													19144	9826	18152	18307	6050	6407
HPY-C3-561-SRO4	16114	8296	15388	15191	5020	5317	21472	11625	23033	15191	5020	5317	26830	14954	30678	15191	5020	5317
HPY-C3-561-SRO5							20381	10595	19917	18307	6050	6407	25739	13924	27562	18307	6050	6407
HPY-C3-561-SRO6													24456	12713	23896	21973	7261	7690
HPY-C3-631-SRO4	19587	9687	16948	21973	7261	7690	26406	13924	26678	17473	7261	7690	33225	18161	36408	21973	7261	7690
HPY-C3-631-SRO5							25225	12810	23300	25346	8376	88718	32044	17047	33035	25346	8376	8871
HPY-C3-631-SRO6													30699	15776	29191	29191	9646	10217
HPY-C4-631-SRO4	23968	12090	21759	24851	8206	8698	32134	17154	33411	24851	8206	8698	40300	22239	45063	24851	8206	8698
HPY-C4-631-SRO5							30377	15505	28386	29876	9866	10457	38542	20579	40038	29876	9866	10457
HPY-C4-631-SRO6													36389	18548	33888	36027	11897	12609
HPY-C4-701-SRO4	29941	15235	27767	29876	9866	10457	40041	21511	42177	29876	9866	10457	50140	27786	56588	29876	9866	10457
HPY-C4-701-SRO5							37888	19480	36027	36027	11897	12609	47988	25755	50437	36027	11897	12609
HPY-C4-701-SRO6													44783	22731	41280	45184	14921	15814
HPY-C4-801-SRO4	40247	20945	39392	36027	11897	12609	53461	29156	58247	36027	11897	12609	66675	37366	77102	36027	11897	12609
HPY-C4-801-SRO5							50256	26132	49090	45184	14921	15814	63470	34342	67945	45184	14921	15814
HPY-C4-801-SRO6													59487	30584	56564	56564	18679	19798
HPY-C5-801-SRO4	47584	24043	45246	45246	14943	15836	63439	34314	67869	45246	14943	15836	79294	44165	90492	45246	14943	15836
HPY-C5-801-SRO5							59200	30314	55758	57357	18943	20075	75055	40166	78381	57357	18943	20075
HPY-C5-801-SRO6													70706	36062	65956	69782	23046	24424
HPY-C5-901-SRO4	60321	31011	57357	57357	18943	20075	80420	43499	86036	57357	18943	20075	100518	55987	114714	57357	18943	20075
HPY-C5-901-SRO5							76071	39396	73611	69782	23046	24424	96170	51884	102290	69782	23046	24424
HPY-C5-901-SRO6													90481	46516	86036	86036	28414	30113
HPY-C6-801-SRO4	63904	32823	60764	60764	20097	21267	85197	46054	91146	60764	20097	21267	106489	59284	121528	60764	20097	21267
HPY-C6-801-SRO5							79490	40661	74843	77068	25490	26974	100783	53891	105225	77068	25490	26974
HPY-C6-801-SRO6													94040	47519	85958	96335	31862	33717
HPY-C6-901-SRO4	81050	41630	77068	77068	25490	26974	108055	58410	115602	77068	25490	26974	135061	75190	154136	77068	25490	26974
HPY-C6-901-SRO5							101312	52038	96335	96335	31862	33717	128318	68818	134869	96335	31862	33717
HPY-C6-901-SRO6													120346	61284	112092	119112	39396	41689
HPY-C6-1001-SRO4	99847	51127	94244	96335	31862	33717	133238	71875	141889	96335	31862	33717	166629	92622	189533	96335	31862	33717
HPY-C6-1001-SRO5							125266	64341	119112	119112	39396	41689	158657	85089	166756	119112	39396	41689
HPY-C6-1001-SRO6													150319	77210	142934	142934	47275	50027

The torque of the springs can be customized to your needs.

## Sizing

During selecting the actuators, we can choose the more reasonable and more economical actuators, if we know the different torque needed by the valve working at opening and operating.

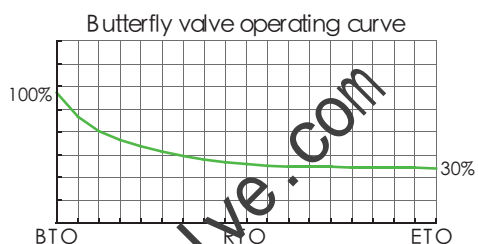
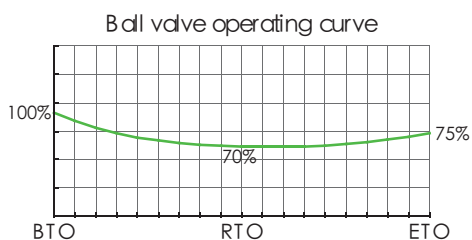

■ Spring return operating curve    ■ Air to spring operating curve    ■ Ball valve (butterfly valve) operating curve

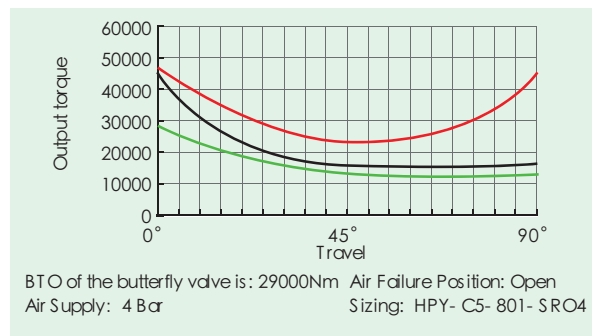
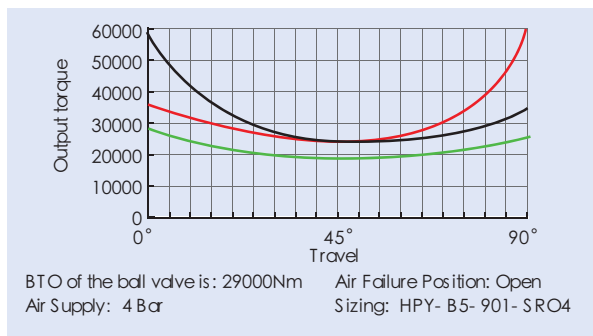
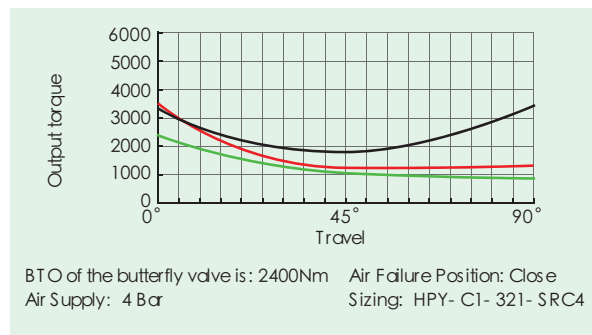
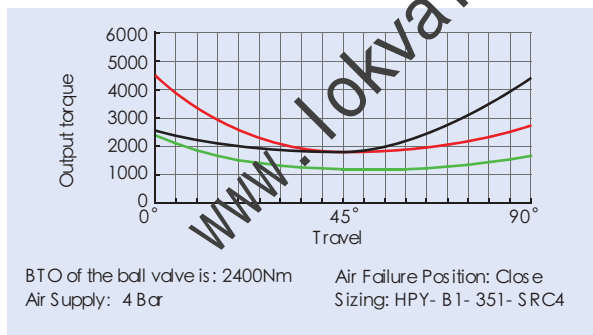
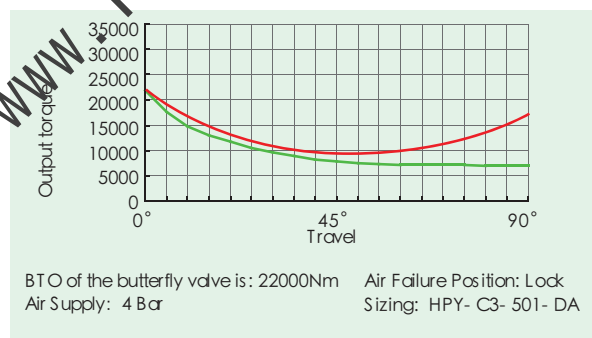
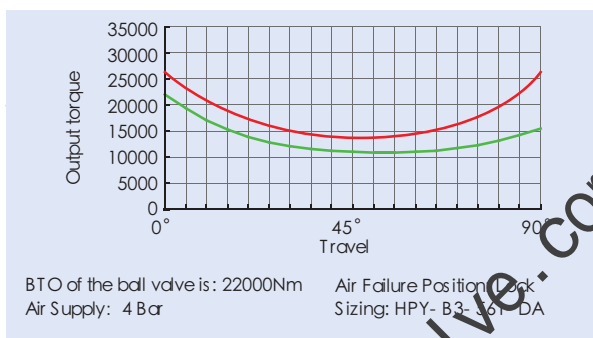



Dimension of HPY- B (C)S eries Double Acting Actuator

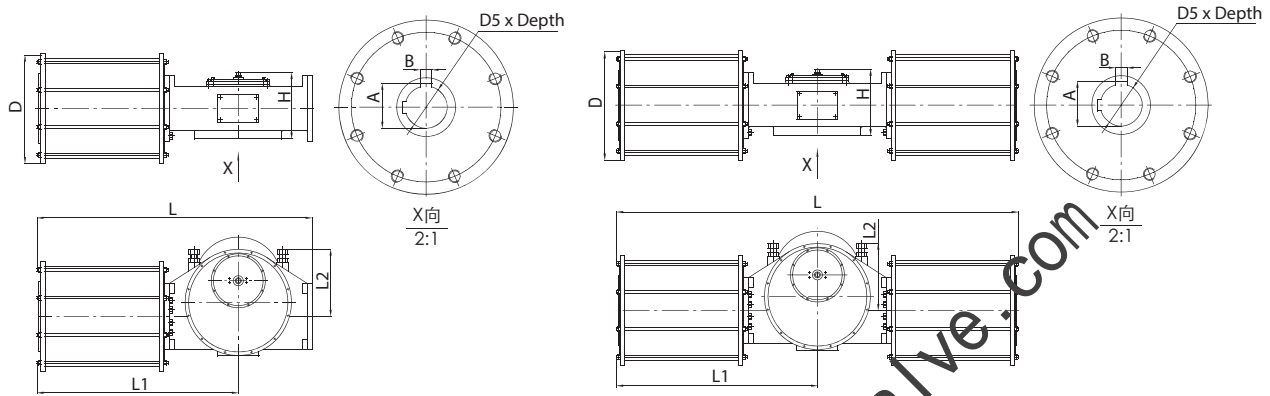

Model	L	L1	L2	H	D	D5	B	Connecting Flange	Air Connection
	mm								ISO 5211
HPY-B/C06-201-DA	675	505	180	212	225*225	Ø48*65	18	F14	3/8"G(NPT)
HPY-B/C08-221-DA	815	605	200	237	250*250	Ø60*100	64.4	F16	1/2"G(NPT)
HPY-B08-251-DA	815	605	200	237	280*280	Ø60*100	64.4	F16	1/2"G(NPT)
HPY-B/C1-281-DA	925	680	225	246	310*310	Ø72*120	76.9	F25/F16	1/2"G(NPT)
HPY-B/C1-321-DA	905	660	225	246	Ø395	Ø72*120	76.9	F25/F16	1/2"G(NPT)
HPY-B1-351-DA	905	660	225	246	Ø430	Ø72*120	76.9	F25/F16	3/4"G(NPT)
HPY-B/C2-351-DA	1055	775	285	269	Ø430	Ø100*150	106.4	F30/F25	3/4"G(NPT)
HPY-B/C2-401-DA	1055	775	285	269	Ø500	Ø100*150	106.4	F30/F25	1"G(NPT)
HPY-B/C2-451-DA	1055	775	285	269	Ø550	Ø100*150	106.4	F30/F25	1"G(NPT)
HPY-B/C3-451-DA	1250	915	330	310	Ø550	Ø160*200	169.4	F35/F30	1"G(NPT)
HPY-B/C3-501-DA	1250	915	330	310	Ø600	Ø160*200	169.4	F35/F30	1 1/4"G(NPT)
HPY-B/C3-561-DA	1250	915	330	310	Ø660	Ø160*200	169.4	F35/F30	1 1/4"G(NPT)
HPY-B3-601-DA	1250	915	330	310	Ø700	Ø160*200	169.4	F35/F30	1 1/4"G(NPT)
HPY-C4-561-DA	1450	1050	412	340	Ø660	Ø180*220	190.4	F40	1 1/4"G(NPT)
HPY-B/C4-601-DA	1450	1050	412	340	Ø700	Ø180*220	190.4	F40	1 1/4"G(NPT)
HPY-B/C4-631-DA	1450	1050	412	340	Ø730	Ø180*220	190.4	F40	1 1/2"G(NPT)
HPY-B/C4-701-DA	1450	1050	412	340	Ø810	Ø180*220	190.4	F40	1 1/2"G(NPT)
HPY-B4-801-DA	1450	1050	412	340	Ø910	Ø180*220	190.4	F40	1 1/2"G(NPT)
HPY-B/C4-502-DA	1450	1050	412	340	Ø600	Ø180*220	190.4	F40	1 1/4"G(NPT)
HPY-B4-562-DA	1450	1050	412	340	Ø660	Ø180*220	190.4	F40	1 1/4"G(NPT)
HPY-B/C5-701-DA	1690	1230	486	420	Ø810	Ø220*250	231.4	F48/F40	1 1/2"G(NPT)
HPY-B/C5-801-DA	1690	1230	486	420	Ø910	Ø220*250	231.4	F48/F40	1 1/2"G(NPT)
HPY-B/C5-901-DA	1690	1230	486	420	Ø1010	Ø220*250	231.4	F48/F40	2"G(NPT)
HPY-B5-1001-DA	1690	1230	486	420	Ø1110	Ø220*250	231.4	F48/F40	2"G(NPT)
HPY-B/C5-562-DA	2456	1230	486	420	Ø660	Ø220*250	231.4	F48/F40	1 1/4"G(NPT)
HPY-B/C5-602-DA	2456	1230	486	420	Ø700	Ø220*250	231.4	F48/F40	1 1/4"G(NPT)
HPY-B/C5-632-DA	2456	1230	486	420	Ø730	Ø220*250	231.4	F48/F40	1 1/2"G(NPT)
HPY-B5-702-DA	2456	1230	486	420	Ø810	Ø220*250	231.4	F48/F40	1 1/2"G(NPT)
HPY-C6-801-DA	2145	1555	658	490	Ø910	Ø280*320	292.4	F60/F48	1 1/2"G(NPT)
HPY-B/C6-901-DA	2145	1555	658	490	Ø1010	Ø280*320	292.4	F60/F48	2"G(NPT)
HPY-B/C6-1001-DA	2145	1555	658	490	Ø1110	Ø280*320	292.4	F60/F48	2"G(NPT)
HPY-B/C6-702-DA	3100	1555	658	490	Ø810	Ø280*320	292.4	F60/F48	1 1/2"G(NPT)
HPY-B/C6-802-DA	3100	1555	658	490	Ø910	Ø280*320	292.4	F60/F48	1 1/2"G(NPT)
HPY-B6-902-DA	3100	1555	658	490	Ø1010	Ø280*320	292.4	F60/F48	2"G(NPT)

The dimension of D5 can be customized according to your requirements.

## Dimension of HPY- B FC(O) S series Spring Return Actuator

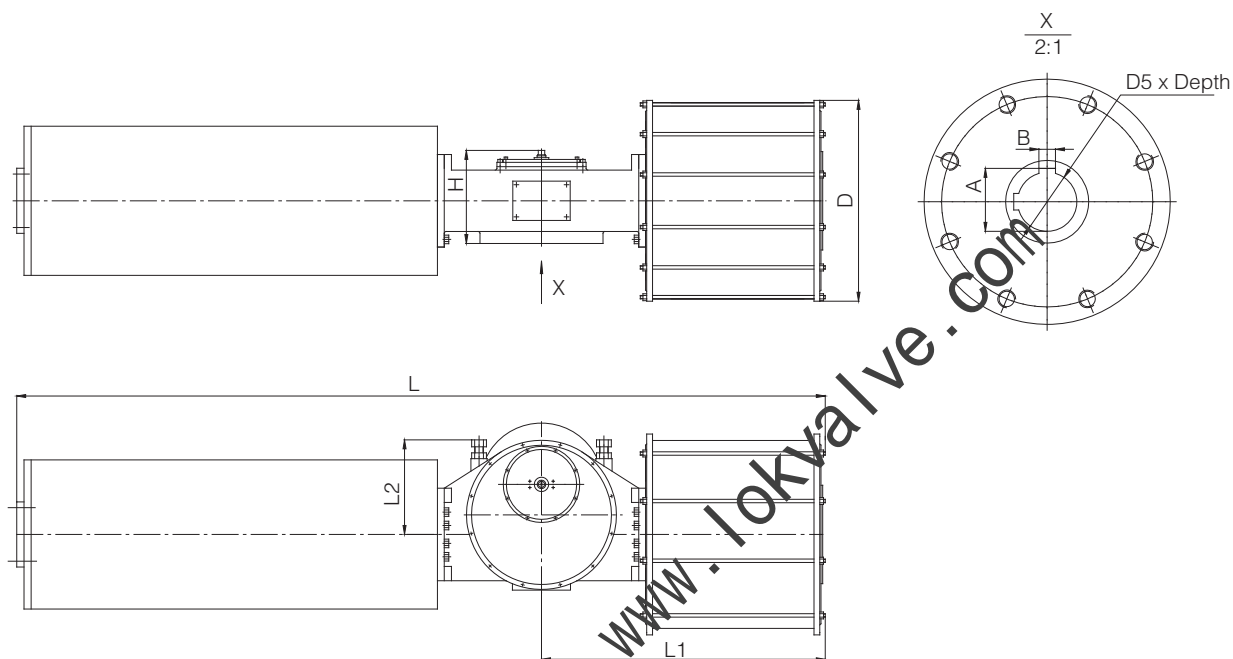

Model 型号	L	L1	L2	H	D	D5xDepth	A	B	Connecting Flange 连接法兰	Air Connection 气源接口
									ISO5211	
HPY-B06-201-SRO4	1304	505	180	214	□225	Ø48x65	51.8	14	F14	3/8"G(NPT)
HPY-B06-201-SRO5	1354	505	180	214	□225	Ø48x65	51.8	14	F14	3/8"G(NPT)
HPY-B06-201-SRO6	1374	505	180	214	□225	Ø48x65	51.8	14	F14	3/8"G(NPT)
HPY-B06-221-SRO4	1354	515	180	214	□250	Ø48x65	51.8	14	F14	1/2"G(NPT)
HPY-B06-221-SRO5	1374	515	180	214	□250	Ø48x65	51.8	14	F14	1/2"G(NPT)
HPY-B06-221-SRO6	1324	515	180	214	□250	Ø48x65	51.8	14	F14	1/2"G(NPT)
HPY-B08-221-SRO4	1458	605	200	238	□250	Ø60x100	64.4	18	F16	1/2"G(NPT)
HPY-B08-221-SRO5	1488	605	200	238	□250	Ø60x100	64.4	18	F16	1/2"G(NPT)
HPY-B08-221-SRO6	1528	605	200	238	□250	Ø60x100	64.4	18	F16	1/2"G(NPT)
HPY-B08-251-SRO4	1488	605	200	238	□280	Ø60x100	64.4	18	F16	1/2"G(NPT)
HPY-B08-251-SRO5	1528	605	200	238	□280	Ø60x100	64.4	18	F16	1/2"G(NPT)
HPY-B08-251-SRO6	1528	605	200	238	□280	Ø60x100	64.4	18	F16	1/2"G(NPT)
HPY-B08-281-SRO4	1528	605	200	238	□310	Ø60x100	64.4	18	F16	1/2"G(NPT)
HPY-B08-281-SRO5	1528	605	200	238	□310	Ø60x100	64.4	18	F16	1/2"G(NPT)
HPY-B08-281-SRO6	1558	605	200	238	□310	Ø60x100	64.4	18	F16	1/2"G(NPT)
HPY-B1-281-SRO4	1660	680	225	245	□310	Ø72x120	76.9	20	F25/F16	1/2"G(NPT)
HPY-B1-281-SRO5	1690	680	225	245	□310	Ø72x120	76.9	20	F25/F16	1/2"G(NPT)
HPY-B1-281-SRO6	1710	680	225	245	□310	Ø72x120	76.9	20	F25/F16	1/2"G(NPT)
HPY-B1-321-SRO4	1670	660	225	245	Ø395	Ø72x120	76.9	20	F25/F16	1/2"G(NPT)
HPY-B1-321-SRO5	1690	660	225	245	Ø395	Ø72x120	76.9	20	F25/F16	1/2"G(NPT)
HPY-B1-321-SRO6	1710	660	225	245	Ø395	Ø72x120	76.9	20	F25/F16	1/2"G(NPT)
HPY-B1-351-SRO4	1690	660	225	245	Ø430	Ø72x120	76.9	20	F25/F16	3/4"G(NPT)
HPY-B1-351-SRO5	1710	660	225	245	Ø430	Ø72x120	76.9	20	F25/F16	3/4"G(NPT)
HPY-B1-351-SRO6	1730	660	225	245	Ø430	Ø72x120	76.9	20	F25/F16	3/4"G(NPT)

Model 型号	L	L1	L2	H	D	D5×Depth	A	B	Connecting Flange 连接法兰	Air Connection 气源接口
	mm								ISO5211	
HPY-B1-401-SRO4	1710	660	225	245	Ø500	Ø72x120	76.9	20	F25/F16	1"G(NPT)
HPY-B1-401-SRO5	1730	660	225	245	Ø500	Ø72x120	76.9	20	F25/F16	1"G(NPT)
HPY-B1-401-SRO6	1770	660	225	245	Ø500	Ø72x120	76.9	20	F25/F16	1"G(NPT)
HPY-B2-401-SRO4	1915	775	285	269	Ø500	Ø100x150	106.4	28	F30/F25	1"G(NPT)
HPY-B2-401-SRO5	1965	775	285	269	Ø500	Ø100x150	106.4	28	F30/F25	1"G(NPT)
HPY-B2-401-SRO6	2025	775	285	269	Ø500	Ø100x150	106.4	28	F30/F25	1"G(NPT)
HPY-B2-451-SRO4	1965	775	285	269	Ø550	Ø100x150	106.4	28	F30/F25	1"G(NPT)
HPY-B2-451-SRO5	2025	775	285	269	Ø550	Ø100x150	106.4	28	F30/F25	1"G(NPT)
HPY-B2-451-SRO6	2045	775	285	269	Ø550	Ø100x150	106.4	28	F30/F25	1"G(NPT)
HPY-B3-451-SRO4	2223	915	345	310	Ø550	Ø160x200	169.4	40	F35/F30	1"G(NPT)
HPY-B3-451-SRO5	2243	915	345	310	Ø550	Ø160x200	169.4	40	F35/F30	1"G(NPT)
HPY-B3-451-SRO6	2263	915	345	310	Ø550	Ø160x200	169.4	40	F35/F30	1"G(NPT)
HPY-B3-501-SRO4	2243	915	345	310	Ø600	Ø160x200	169.4	40	F35/F30	1 1/4"G(NPT)
HPY-B3-501-SRO5	2263	915	345	310	Ø600	Ø160x200	169.4	40	F35/F30	1 1/4"G(NPT)
HPY-B3-501-SRO6	2323	915	345	310	Ø600	Ø160x200	169.4	40	F35/F30	1 1/4"G(NPT)
HPY-B3-561-SRO4	2263	915	345	310	Ø660	Ø160x200	169.4	40	F35/F30	1 1/4"G(NPT)
HPY-B3-561-SRO5	2323	915	345	310	Ø660	Ø160x200	169.4	40	F35/F30	1 1/4"G(NPT)
HPY-B3-561-SRO6	2383	915	345	310	Ø660	Ø160x200	169.4	40	F35/F30	1 1/4"G(NPT)
HPY-B3-631-SRO4	2383	915	345	310	Ø730	Ø160x200	169.4	40	F35/F30	1 1/2"G(NPT)
HPY-B3-631-SRO5	2383	915	345	310	Ø730	Ø160x200	169.4	40	F35/F30	1 1/2"G(NPT)
HPY-B3-631-SRO6	2423	915	345	310	Ø730	Ø160x200	169.4	40	F35/F30	1 1/2"G(NPT)
HPY-B4-631-SRO4	2784	1050	412	340	Ø730	Ø180x220	190.4	45	F40	1 1/2"G(NPT)
HPY-B4-631-SRO5	2784	1050	412	340	Ø730	Ø180x220	190.4	45	F40	1 1/2"G(NPT)
HPY-B4-631-SRO6	2924	1050	412	340	Ø730	Ø180x220	190.4	45	F40	1 1/2"G(NPT)
HPY-B4-701-SRO4	2784	1050	412	340	Ø810	Ø180x220	190.4	45	F40	1 1/2"G(NPT)
HPY-B4-701-SRO5	2924	1050	412	340	Ø810	Ø180x220	190.4	45	F40	1 1/2"G(NPT)
HPY-B4-701-SRO6	3014	1050	412	340	Ø810	Ø180x220	190.4	45	F40	1 1/2"G(NPT)
HPY-B4-801-SRO4	2924	1050	412	340	Ø910	Ø180x220	190.4	45	F40	1 1/2"G(NPT)
HPY-B4-801-SRO5	3014	1050	412	340	Ø910	Ø180x220	190.4	45	F40	1 1/2"G(NPT)
HPY-B4-801-SRO6	3114	1050	412	340	Ø910	Ø180x220	190.4	45	F40	1 1/2"G(NPT)
HPY-B5-801-SRO4	3273	1230	486	420	Ø910	Ø220x250	231.4	50	F48/F40	1 1/2"G(NPT)
HPY-B5-801-SRO5	3333	1230	486	420	Ø910	Ø220x250	231.4	50	F48/F40	1 1/2"G(NPT)
HPY-B5-801-SRO6	3453	1230	486	420	Ø910	Ø220x250	231.4	50	F48/F40	1 1/2"G(NPT)
HPY-B5-901-SRO4	3333	1230	486	420	Ø1010	Ø220x250	231.4	50	F48/F40	2"G(NPT)
HPY-B5-901-SRO5	3453	1230	486	420	Ø1010	Ø220x250	231.4	50	F48/F40	2"G(NPT)
HPY-B5-901-SRO6	3613	1230	486	420	Ø1010	Ø220x250	231.4	50	F48/F40	2"G(NPT)
HPY-B6-801-SRO4	4070	1555	658	490	Ø910	Ø280x320	292.4	63	F60/F48	1 1/2"G(NPT)
HPY-B6-801-SRO5	4200	1555	658	490	Ø910	Ø280x320	292.4	63	F60/F48	1 1/2"G(NPT)
HPY-B6-801-SRO6	4260	1555	658	490	Ø910	Ø280x320	292.4	63	F60/F48	1 1/2"G(NPT)
HPY-B6-901-SRO4	4200	1555	658	490	Ø1010	Ø280x320	292.4	63	F60/F48	2"G(NPT)
HPY-B6-901-SRO5	4260	1555	658	490	Ø1010	Ø280x320	292.4	63	F60/F48	2"G(NPT)
HPY-B6-901-SRO6	4320	1555	658	490	Ø1010	Ø280x320	292.4	63	F60/F48	2"G(NPT)
HPY-B6-1001-SRO4	4260	1555	658	490	Ø1110	Ø280x320	292.4	63	F60/F48	2"G(NPT)
HPY-B6-1001-SRO5	4320	1555	658	490	Ø1110	Ø280x320	292.4	63	F60/F48	2"G(NPT)
HPY-B6-1001-SRO6	4380	1555	658	490	Ø1110	Ø280x320	292.4	63	F60/F48	2"G(NPT)

The dimension of D5 can be customized according to your requirements.

## Dimension of HPY- C (FC)S eries Spring Return Actuator

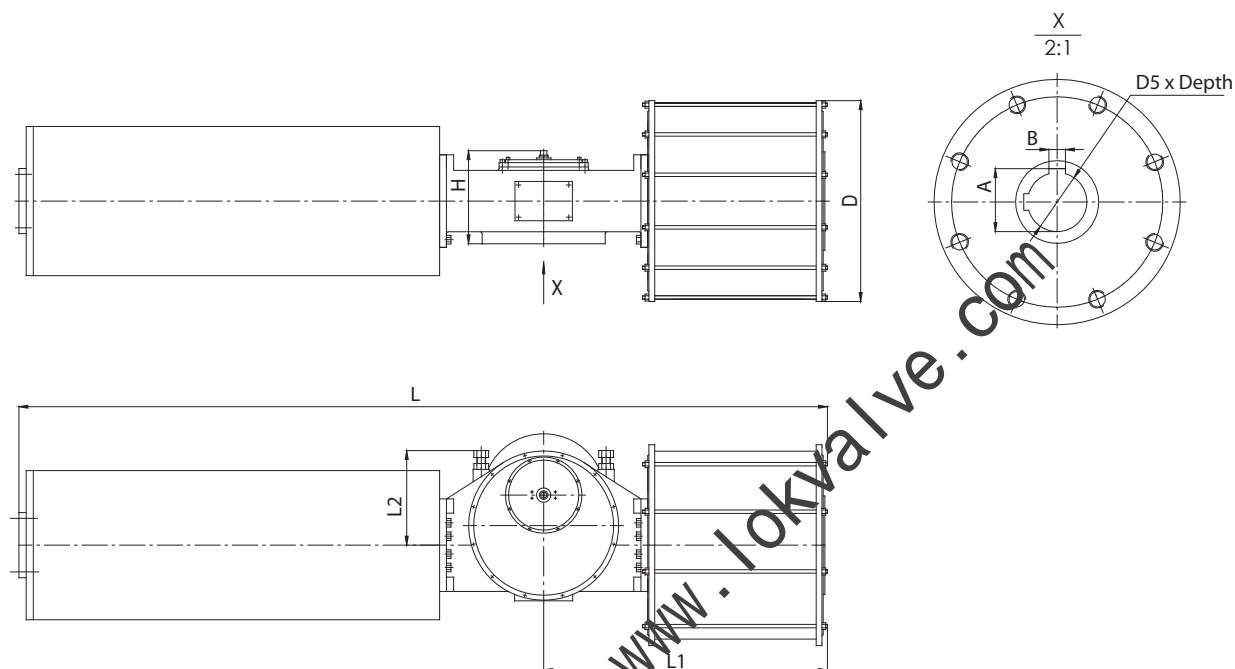

Model 型号	L	L1	L2	H	D	D5×Depth	A	B	Connecting Flange 连接法兰	Air Connection 气源接口
									ISO5211	
HPY-C06-201-SRC4	1323	505	180	214	□225	Ø48x65	51.8	14	F14	3/8"G(NPT)
HPY-C06-201-SRC5	1343	505	180	214	□225	Ø48x65	51.8	14	F14	3/8"G(NPT)
HPY-C06-201-SRC6	1383	505	180	214	□225	Ø48x65	51.8	14	F14	3/8"G(NPT)
HPY-C06-221-SRC4	1343	515	180	214	□250	Ø48x65	51.8	14	F14	1/2"G(NPT)
HPY-C06-221-SRC5	1383	515	180	214	□250	Ø48x65	51.8	14	F14	1/2"G(NPT)
HPY-C06-221-SRC6	1423	515	180	214	□250	Ø48x65	51.8	14	F14	1/2"G(NPT)
HPY-C08-221-SRC4	1487	605	200	238	□250	Ø60x100	64.4	18	F16	1/2"G(NPT)
HPY-C08-221-SRC5	1507	605	200	238	□250	Ø60x100	64.4	18	F16	1/2"G(NPT)
HPY-C08-221-SRC6	1527	605	200	238	□250	Ø60x100	64.4	18	F16	1/2"G(NPT)
HPY-C08-251-SRC4	1507	605	200	238	□280	Ø60x100	64.4	18	F16	1/2"G(NPT)
HPY-C08-251-SRC5	1527	605	200	238	□280	Ø60x100	64.4	18	F16	1/2"G(NPT)
HPY-C08-251-SRC6	1567	605	200	238	□280	Ø60x100	64.4	18	F16	1/2"G(NPT)
HPY-C08-281-SRC4	1527	605	200	238	□310	Ø60x100	64.4	18	F16	1/2"G(NPT)
HPY-C08-281-SRC5	1567	605	200	238	□310	Ø60x100	64.4	18	F16	1/2"G(NPT)
HPY-C08-281-SRC6	1597	605	200	238	□310	Ø60x100	64.4	18	F16	1/2"G(NPT)
HPY-C1-281-SRC4	1740	680	225	246	□310	Ø72x120	76.9	20	F25/F16	1/2"G(NPT)
HPY-C1-281-SRC5	1720	680	225	246	□310	Ø72x120	76.9	20	F25/F16	1/2"G(NPT)
HPY-C1-281-SRC6	1720	680	225	246	□310	Ø72x120	76.9	20	F25/F16	1/2"G(NPT)
HPY-C1-321-SRC4	1700	660	225	246	Ø395	Ø72x120	76.9	20	F25/F16	1/2"G(NPT)
HPY-C1-321-SRC5	1700	660	225	246	Ø395	Ø72x120	76.9	20	F25/F16	1/2"G(NPT)
HPY-C1-321-SRC6	1720	660	225	246	Ø395	Ø72x120	76.9	20	F25/F16	1/2"G(NPT)
HPY-C1-351-SRC4	1700	660	225	246	Ø430	Ø72x120	76.9	20	F25/F16	3/4"G(NPT)
HPY-C1-351-SRC5	1720	660	225	246	Ø430	Ø72x120	76.9	20	F25/F16	3/4"G(NPT)
HPY-C1-351-SRC6	1800	660	225	246	Ø430	Ø72x120	76.9	20	F25/F16	3/4"G(NPT)

Model 型号	L	L1	L2	H	D	D5×Depth	A	B	Connecting Flange 连接法兰	Air Connection 气源接口
	mm								ISO5211	
HPY-C1-401-SRC4	1720	660	225	246	Ø500	Ø72x120	76.9	20	F25/F16	1"G(NPT)
HPY-C1-401-SRC5	1750	660	225	246	Ø500	Ø72x120	76.9	20	F25/F16	1"G(NPT)
HPY-C1-401-SRC6	1762	660	225	246	Ø500	Ø72x120	76.9	20	F25/F16	1"G(NPT)
HPY-C2-401-SRC4	1961	775	285	267	Ø500	Ø100x150	106.4	28	F30/F25	1"G(NPT)
HPY-C2-401-SRC5	1961	775	285	267	Ø500	Ø100x150	106.4	28	F30/F25	1"G(NPT)
HPY-C2-401-SRC6	1991	775	285	267	Ø500	Ø100x150	106.4	28	F30/F25	1"G(NPT)
HPY-C2-451-SRC4	1961	775	285	267	Ø550	Ø100x150	106.4	28	F30/F25	1"G(NPT)
HPY-C2-451-SRC5	1991	775	285	267	Ø550	Ø100x150	106.4	28	F30/F25	1"G(NPT)
HPY-C2-451-SRC6	2041	775	285	267	Ø550	Ø100x150	106.4	28	F30/F25	1"G(NPT)
HPY-C3-451-SRC4	2231	915	345	310	Ø550	Ø160x200	169.4	40	F35/F30	1"G(NPT)
HPY-C3-451-SRC5	2251	915	345	310	Ø550	Ø160x200	169.4	40	F35/F30	1"G(NPT)
HPY-C3-451-SRC6	2351	915	345	310	Ø550	Ø160x200	169.4	40	F35/F30	1"G(NPT)
HPY-C3-501-SRC4	2251	915	345	310	Ø600	Ø160x200	169.4	40	F35/F30	1 1/4"G(NPT)
HPY-C3-501-SRC5	2351	915	345	310	Ø600	Ø160x200	169.4	40	F35/F30	1 1/4"G(NPT)
HPY-C3-501-SRC6	2401	915	345	310	Ø600	Ø160x200	169.4	40	F35/F30	1 1/4"G(NPT)
HPY-C3-561-SRC4	2351	915	345	310	Ø660	Ø160x200	169.4	40	F35/F30	1 1/4"G(NPT)
HPY-C3-561-SRC5	2401	915	345	310	Ø660	Ø160x200	169.4	40	F35/F30	1 1/4"G(NPT)
HPY-C3-561-SRC6	2451	915	345	310	Ø660	Ø160x200	169.4	40	F35/F30	1 1/4"G(NPT)
HPY-C3-631-SRC4	2401	915	345	310	Ø730	Ø160x200	169.4	40	F35/F30	1 1/2"G(NPT)
HPY-C3-631-SRC5	2511	915	345	310	Ø730	Ø160x200	169.4	40	F35/F30	1 1/2"G(NPT)
HPY-C3-631-SRC6	2591	915	345	310	Ø730	Ø160x200	169.4	40	F35/F30	1 1/2"G(NPT)
HPY-C4-631-SRC4	2751	1050	412	340	Ø730	Ø180x220	190.4	45	F40	1 1/2"G(NPT)
HPY-C4-631-SRC5	2831	1050	412	340	Ø730	Ø180x220	190.4	45	F40	1 1/2"G(NPT)
HPY-C4-631-SRC6	2911	1050	412	340	Ø730	Ø180x220	190.4	45	F40	1 1/2"G(NPT)
HPY-C4-701-SRC4	2831	1050	412	340	Ø810	Ø180x220	190.4	45	F40	1 1/2"G(NPT)
HPY-C4-701-SRC5	2911	1050	412	340	Ø810	Ø180x220	190.4	45	F40	1 1/2"G(NPT)
HPY-C4-701-SRC6	2951	1050	412	340	Ø810	Ø180x220	190.4	45	F40	1 1/2"G(NPT)
HPY-C4-801-SRC4	2911	1050	412	340	Ø910	Ø180x220	190.4	45	F40	1 1/2"G(NPT)
HPY-C4-801-SRC5	2951	1050	412	340	Ø910	Ø180x220	190.4	45	F40	1 1/2"G(NPT)
HPY-C4-801-SRC6	3021	1050	412	340	Ø910	Ø180x220	190.4	45	F40	1 1/2"G(NPT)
HPY-C5-801-SRC4	3273	1230	486	420	Ø910	Ø220x250	231.4	50	F48/F40	1 1/2"G(NPT)
HPY-C5-801-SRC5	3493	1230	486	420	Ø910	Ø220x250	231.4	50	F48/F40	1 1/2"G(NPT)
HPY-C5-801-SRC6	3613	1230	486	420	Ø910	Ø220x250	231.4	50	F48/F40	1 1/2"G(NPT)
HPY-C5-901-SRC4	3493	1230	486	420	Ø1010	Ø220x250	231.4	50	F48/F40	2"G(NPT)
HPY-C5-901-SRC5	3613	1230	486	420	Ø1010	Ø220x250	231.4	50	F48/F40	2"G(NPT)
HPY-C5-901-SRC6	3773	1230	486	420	Ø1010	Ø220x250	231.4	50	F48/F40	2"G(NPT)
HPY-C6-801-SRC4	4050	1555	658	490	Ø910	Ø280x320	292.4	63	F60/F48	1 1/2"G(NPT)
HPY-C6-801-SRC5	4310	1555	658	490	Ø910	Ø280x320	292.4	63	F60/F48	1 1/2"G(NPT)
HPY-C6-801-SRC6	4320	1555	658	490	Ø910	Ø280x320	292.4	63	F60/F48	1 1/2"G(NPT)
HPY-C6-901-SRC4	4310	1555	658	490	Ø1010	Ø280x320	292.4	63	F60/F48	2"G(NPT)
HPY-C6-901-SRC5	4320	1555	658	490	Ø1010	Ø280x320	292.4	63	F60/F48	2"G(NPT)
HPY-C6-901-SRC6	4430	1555	658	490	Ø1010	Ø280x320	292.4	63	F60/F48	2"G(NPT)
HPY-C6-1001-SRC4	4320	1555	658	490	Ø1110	Ø280x320	292.4	63	F60/F48	2"G(NPT)
HPY-C6-1001-SRC5	4430	1555	658	490	Ø1110	Ø280x320	292.4	63	F60/F48	2"G(NPT)
HPY-C6-1001-SRC6	4600	1555	658	490	Ø1110	Ø280x320	292.4	63	F60/F48	2"G(NPT)

The dimension of D5 can be customized according to your requirements.



## Dimension of HPY- C (FO)Series Spring Return Actuator

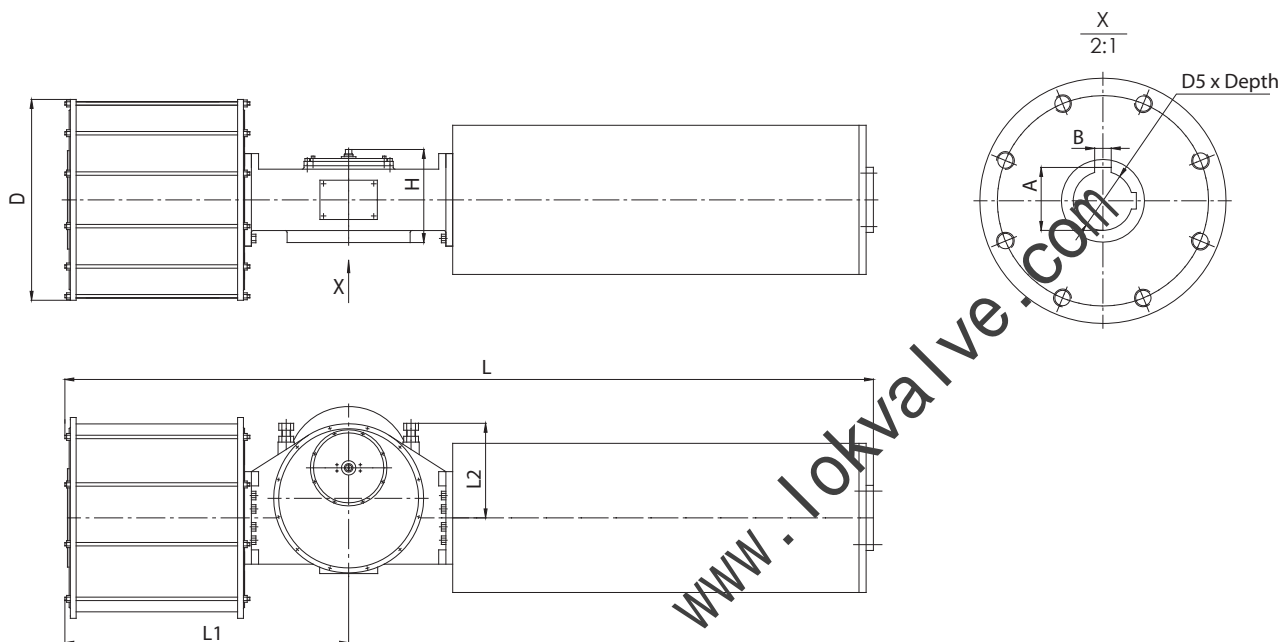

Model 型号	L	L1	L2	H	D	D5×Depth	A	B	Connecting Flange 连接法兰	Air Connection 气源接口
									ISO5211	
HPY-C06-201-SRO4	1348	505	180	214	□225	Ø48x65	51.8	14	F14	3/8"G(NPT)
HPY-C06-201-SRO5	1298	505	180	214	□225	Ø48x65	51.8	14	F14	3/8"G(NPT)
HPY-C06-201-SRO6	1328	505	180	214	□225	Ø48x65	51.8	14	F14	3/8"G(NPT)
HPY-C06-221-SRO4	1298	515	180	214	□250	Ø48x65	51.8	14	F14	1/2"G(NPT)
HPY-C06-221-SRO5	1328	515	180	214	□250	Ø48x65	51.8	14	F14	1/2"G(NPT)
HPY-C06-221-SRO6	1348	515	180	214	□250	Ø48x65	51.8	14	F14	1/2"G(NPT)
HPY-C08-221-SRO4	1487	605	200	238	□250	Ø60x100	64.4	18	F16	1/2"G(NPT)
HPY-C08-221-SRO5	1487	605	200	238	□250	Ø60x100	64.4	18	F16	1/2"G(NPT)
HPY-C08-221-SRO6	1487	605	200	238	□250	Ø60x100	64.4	18	F16	1/2"G(NPT)
HPY-C08-251-SRO4	1487	605	200	238	□280	Ø60x100	64.4	18	F16	1/2"G(NPT)
HPY-C08-251-SRO5	1487	605	200	238	□280	Ø60x100	64.4	18	F16	1/2"G(NPT)
HPY-C08-251-SRO6	1507	605	200	238	□280	Ø60x100	64.4	18	F16	1/2"G(NPT)
HPY-C08-281-SRO4	1487	605	200	238	□310	Ø60x100	64.4	18	F16	1/2"G(NPT)
HPY-C08-281-SRO5	1507	605	200	238	□310	Ø60x100	64.4	18	F16	1/2"G(NPT)
HPY-C08-281-SRO6	1537	605	200	238	□310	Ø60x100	64.4	18	F16	1/2"G(NPT)
HPY-C1-281-SRO4	1680	680	225	246	□310	Ø72x120	76.9	20	F25/F16	1/2"G(NPT)
HPY-C1-281-SRO5	1680	680	225	246	□310	Ø72x120	76.9	20	F25/F16	1/2"G(NPT)
HPY-C1-281-SRO6	1680	680	225	246	□310	Ø72x120	76.9	20	F25/F16	1/2"G(NPT)
HPY-C1-321-SRO4	1660	660	225	246	Ø395	Ø72x120	76.9	20	F25/F16	1/2"G(NPT)
HPY-C1-321-SRO5	1660	660	225	246	Ø395	Ø72x120	76.9	20	F25/F16	1/2"G(NPT)
HPY-C1-321-SRO6	1710	660	225	246	Ø395	Ø72x120	76.9	20	F25/F16	1/2"G(NPT)
HPY-C1-351-SRO4	1660	660	225	246	Ø430	Ø72x120	76.9	20	F25/F16	3/4"G(NPT)
HPY-C1-351-SRO5	1710	660	225	246	Ø430	Ø72x120	76.9	20	F25/F16	3/4"G(NPT)
HPY-C1-351-SRO6	1710	660	225	246	Ø430	Ø72x120	76.9	20	F25/F16	3/4"G(NPT)

Model 型号	L	L1	L2	H	D	D5×Depth	A	B	Connecting Flange 连接法兰	Air Connection 气源接口
	mm								ISO5211	
HPY-C1-401-SRO4	1710	660	225	246	Ø500	Ø72x120	76.9	20	F25/F16	1"G(NPT)
HPY-C1-401-SRO5	1710	660	225	246	Ø500	Ø72x120	76.9	20	F25/F16	1"G(NPT)
HPY-C1-401-SRO6	1730	660	225	246	Ø500	Ø72x120	76.9	20	F25/F16	1"G(NPT)
HPY-C2-401-SRO4	1898	775	285	269	Ø500	Ø100x150	106.4	28	F30/F25	1"G(NPT)
HPY-C2-401-SRO5	1928	775	285	269	Ø500	Ø100x150	106.4	28	F30/F25	1"G(NPT)
HPY-C2-401-SRO6	1948	775	285	269	Ø500	Ø100x150	106.4	28	F30/F25	1"G(NPT)
HPY-C2-451-SRO4	1928	775	285	269	Ø550	Ø100x150	106.4	28	F30/F25	1"G(NPT)
HPY-C2-451-SRO5	1948	775	285	269	Ø550	Ø100x150	106.4	28	F30/F25	1"G(NPT)
HPY-C2-451-SRO6	1948	775	285	269	Ø550	Ø100x150	106.4	28	F30/F25	1"G(NPT)
HPY-C3-451-SRO4	2143	915	345	310	Ø550	Ø160x200	169.4	40	F35/F30	1"G(NPT)
HPY-C3-451-SRO5	2193	915	345	310	Ø550	Ø160x200	169.4	40	F35/F30	1"G(NPT)
HPY-C3-451-SRO6	2193	915	345	310	Ø550	Ø160x200	169.4	40	F35/F30	1"G(NPT)
HPY-C3-501-SRO4	2193	915	345	310	Ø600	Ø160x200	169.4	40	F35/F30	1 1/4"G(NPT)
HPY-C3-501-SRO5	2193	915	345	310	Ø600	Ø160x200	169.4	40	F35/F30	1 1/4"G(NPT)
HPY-C3-501-SRO6	2243	915	345	310	Ø600	Ø160x200	169.4	40	F35/F30	1 1/4"G(NPT)
HPY-C3-561-SRO4	2193	915	345	310	Ø660	Ø160x200	169.4	40	F35/F30	1 1/4"G(NPT)
HPY-C3-561-SRO5	2243	915	345	310	Ø660	Ø160x200	169.4	40	F35/F30	1 1/4"G(NPT)
HPY-C3-561-SRO6	2273	915	345	310	Ø660	Ø160x200	169.4	40	F35/F30	1 1/4"G(NPT)
HPY-C3-631-SRO4	2273	915	345	310	Ø730	Ø160x200	169.4	40	F35/F30	1 1/2"G(NPT)
HPY-C3-631-SRO5	2323	915	345	310	Ø730	Ø160x200	169.4	40	F35/F30	1 1/2"G(NPT)
HPY-C3-631-SRO6	2373	915	345	310	Ø730	Ø160x200	169.4	40	F35/F30	1 1/2"G(NPT)
HPY-C4-631-SRO4	2667	1050	412	340	Ø730	Ø180x220	190.4	45	F40	1 1/2"G(NPT)
HPY-C4-631-SRO5	2693	1050	412	340	Ø730	Ø180x220	190.4	45	F40	1 1/2"G(NPT)
HPY-C4-631-SRO6	2763	1050	412	340	Ø730	Ø180x220	190.4	45	F40	1 1/2"G(NPT)
HPY-C4-701-SRO4	2693	1050	412	340	Ø810	Ø180x220	190.4	45	F40	1 1/2"G(NPT)
HPY-C4-701-SRO5	2763	1050	412	340	Ø810	Ø180x220	190.4	45	F40	1 1/2"G(NPT)
HPY-C4-701-SRO6	2843	1050	412	340	Ø810	Ø180x220	190.4	45	F40	1 1/2"G(NPT)
HPY-C4-801-SRO4	2763	1050	412	340	Ø910	Ø180x220	190.4	45	F40	1 1/2"G(NPT)
HPY-C4-801-SRO5	2843	1050	412	340	Ø910	Ø180x220	190.4	45	F40	1 1/2"G(NPT)
HPY-C4-801-SRO6	2893	1050	412	340	Ø910	Ø180x220	190.4	45	F40	1 1/2"G(NPT)
HPY-C5-801-SRO4	3216	1230	486	420	Ø910	Ø220x250	231.4	50	F48/F40	1 1/2"G(NPT)
HPY-C5-801-SRO5	3236	1230	486	420	Ø910	Ø220x250	231.4	50	F48/F40	1 1/2"G(NPT)
HPY-C5-801-SRO6	3296	1230	486	420	Ø910	Ø220x250	231.4	50	F48/F40	1 1/2"G(NPT)
HPY-C5-901-SRO4	3236	1230	486	420	Ø1010	Ø220x250	231.4	50	F48/F40	2"G(NPT)
HPY-C5-901-SRO5	3296	1230	486	420	Ø1010	Ø220x250	231.4	50	F48/F40	2"G(NPT)
HPY-C5-901-SRO6	3386	1230	486	420	Ø1010	Ø220x250	231.4	50	F48/F40	2"G(NPT)
HPY-C6-801-SRO4	4092	1555	658	490	Ø910	Ø280x320	292.4	63	F60/F48	1 1/2"G(NPT)
HPY-C6-801-SRO5	4167	1555	658	490	Ø910	Ø280x320	292.4	63	F60/F48	1 1/2"G(NPT)
HPY-C6-801-SRO6	4177	1555	658	490	Ø910	Ø280x320	292.4	63	F60/F48	1 1/2"G(NPT)
HPY-C6-901-SRO4	4167	1555	658	490	Ø1010	Ø280x320	292.4	63	F60/F48	2"G(NPT)
HPY-C6-901-SRO5	4177	1555	658	490	Ø1010	Ø280x320	292.4	63	F60/F48	2"G(NPT)
HPY-C6-901-SRO6	4087	1555	658	490	Ø1010	Ø280x320	292.4	63	F60/F48	2"G(NPT)
HPY-C6-1001-SRO4	4177	1555	658	490	Ø1110	Ø280x320	292.4	63	F60/F48	2"G(NPT)
HPY-C6-1001-SRO5	4087	1555	658	490	Ø1110	Ø280x320	292.4	63	F60/F48	2"G(NPT)
HPY-C6-1001-SRO6	4247	1555	658	490	Ø1110	Ø280x320	292.4	63	F60/F48	2"G(NPT)

The dimension of D5 can be customized according to your requirements.

## Modular Design

The HP Series adds an extra measure of versatility with its field serviceable modular configuration. It can be altered from a single acting to a double-acting and add a hydraulic manual override after installation. Both the module and spring modules are removable without the need for special tools or disassembly of any modules.

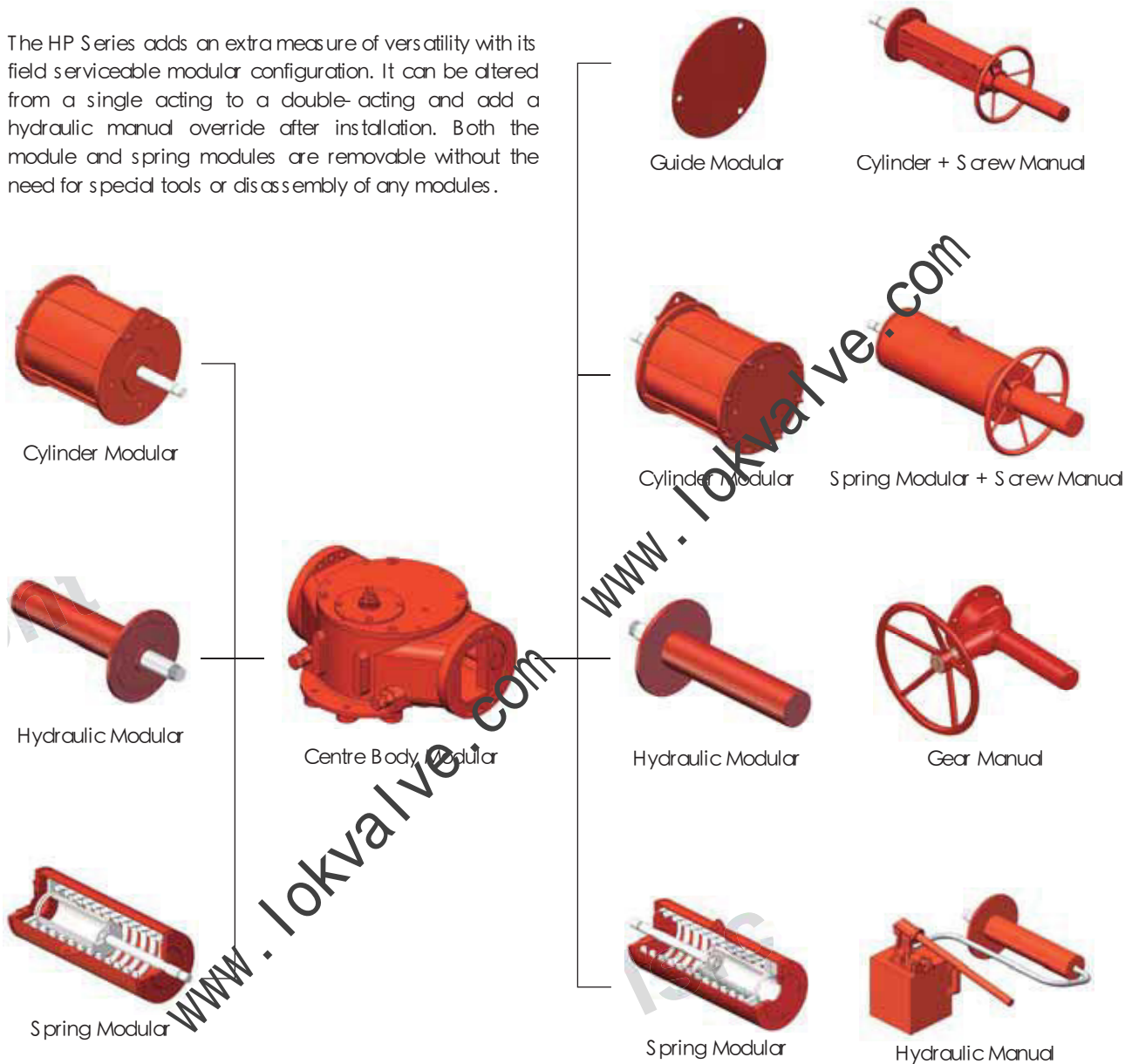

## Body Connecting Dimension

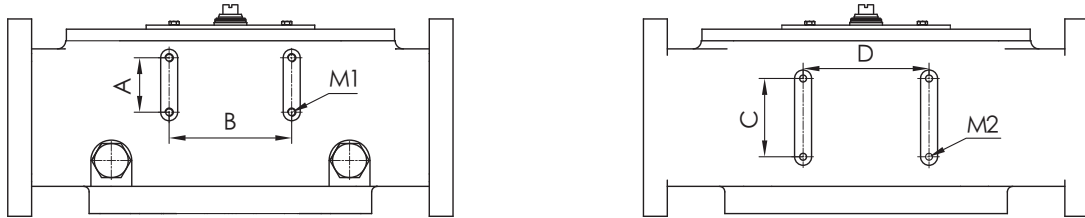

Body No.	AxB	CxD	Screwed Hole M1	Screwed Hole M2
B06/C06	50x90	80x125	4- M12 deep 18	4- M12 deep 18
B08/C08	50x125	80x125	4- M12 deep 18	4- M12 deep 18
B1/C1	50x125	80x125	4- M12 deep 18	4- M12 deep 18
B2/C2	80x125	95x155	4- M12 deep 18	4- M12 deep 18
B3/C3	80x180	115x185	4- M12 deep 18	4- M12 deep 18
B4/C4	80x220	115x230	4- M12 deep 18	4- M12 deep 18
B5/C5	80x220	140x310	4- M12 deep 18	4- M12 deep 18
B6/C6	100x220	180x400	4- M12 deep 18	4- M12 deep 18

UNIT	1	2	3	4	6	7	8	Product code
CONTENT	Series	Structure	Body	Cylinder	Acting Type	Spring	Manual	Specific Requirements
CODE	HP	Y	C1	501	SR	O4	HM	LT
EXAMPLE	HP	Y	C1	501	SR	O4	HM	LT

Y: Yoke

B03 C06  
B08 C08  
B1 C1  
...  
B6 C6

DA Double Acting  
SR Spring Return

SM Screw Manual  
GM Gear Manual  
HM Hydraulic Manual

LT Low Temperature (-40°C to +80°C)  
HT High Temperature (-20°C to +150°C)  
HF High Frequency  
C Customer

501 500mm\*1  
602 600mm\*2  
.....  
1001 1000mm\*1

O Failure Open  
C Failure Close  
4 Spring Size  
5 Spring Size



[www.lokvalve.com](http://www.lokvalve.com) [www.lokvalve.com](http://www.lokvalve.com)